

MOUNTING COMPONENTS

Surface

Lengths
Feeds
Joiners
Connectors

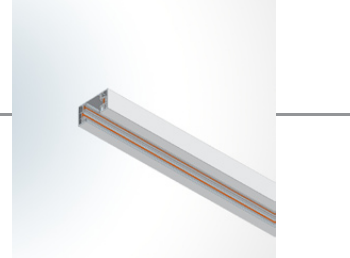

Hanging

Lengths
Feeds
Joiners
Connectors

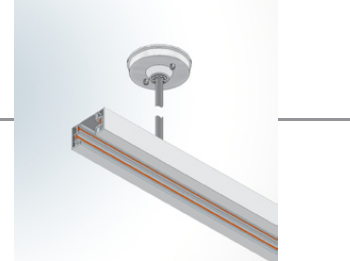

120/230 Volts

Basic Track

Single-Circuit

Project:

Surface/Hanging

BT-Series

Type:

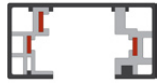

Model	Voltage	Description
	120 Volts 230 Volts	

Track Lengths

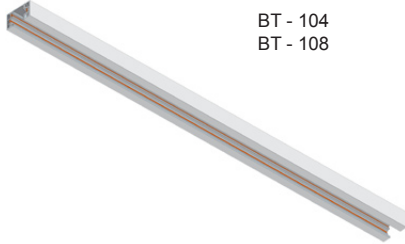

- BT - 104 4-foot track segment
- BT - 108 8-foot track segment

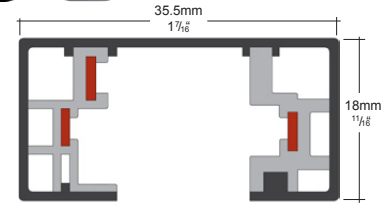

Mounting

Maximum 4' on-center between mounting points.

Surface-mount to hard ceilings using suitable hardware by others. For other applications order hardware, below:

J-Box Feed

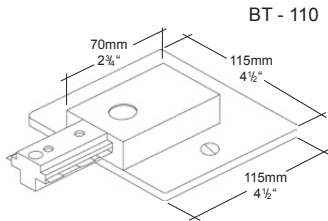

- BT - 110 surface mount for j-box end-feeding of BT Track - includes live end, u-canopy and mounting plate for 4" box.

Optional

- BT - 151 T-Bar Surface -Mount Clips

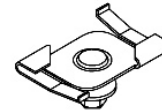

Conduit Feed

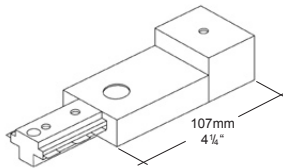

- BT - 156 for conduit end-feeding of BT Track.

Pendant-Mount

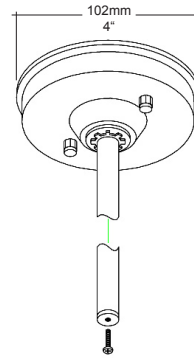

- BT - 119 18" nominal from ceiling to bottom of track.

Pendant Feed Kit

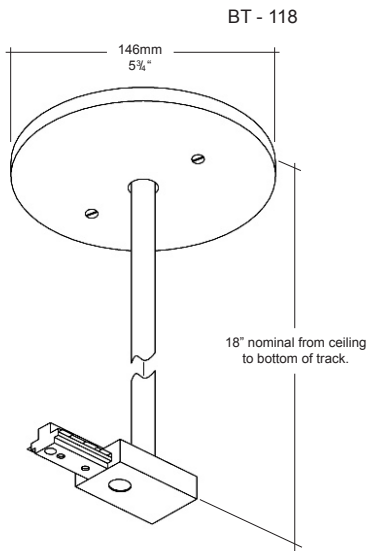

- BT - 118 for end-feeding and support of BT Track - includes canopy, 18" stem, live end and mounting plate for 4" box.

Fixture Adapter

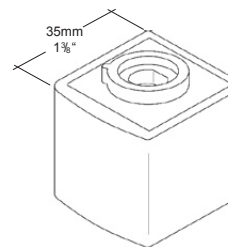

Specify: Fixture Model -8BT

Specify

Model Finish Code

Example: BT - 108 P

Track Finishes

- MB black
- P white

120/230 Volts

Basic Track

Single-Circuit

Project:

Surface/Hanging

BT-Series

Type:



Model	Voltage	Description
-------	---------	-------------

120 Volts
230 Volts

Center Feed

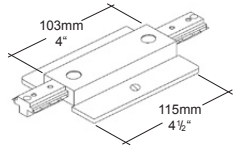

BT - 158

- joins two BT Track lengths end-to-end and allows power feed in the middle of a run.

Straight Connector

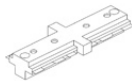

BT - 111

- joins two BT Track lengths end-to-end.

L-Connector

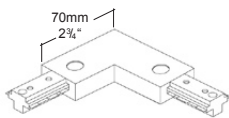

BT - 112

- joins two BT Track lengths to make a 90° turn.

T-Connector

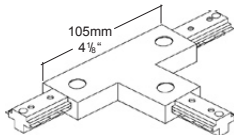

BT - 113

- joins three BT Track lengths.

X-Connector

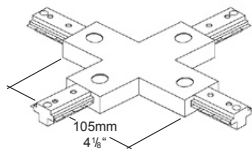

BT - 114

- joins four BT Track lengths at 90° angles.

Flexible Connector

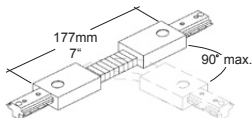

BT - 126

- joins two BT Track lengths at variable angles.

Specify

Model

Finish Code

Track Finishes

Example:

BT - 126

P

MB black
P white