

Extrusion Profile:

BUS-11

Mounting Condition:

Recessed (R) T-BAR, TRIMMED

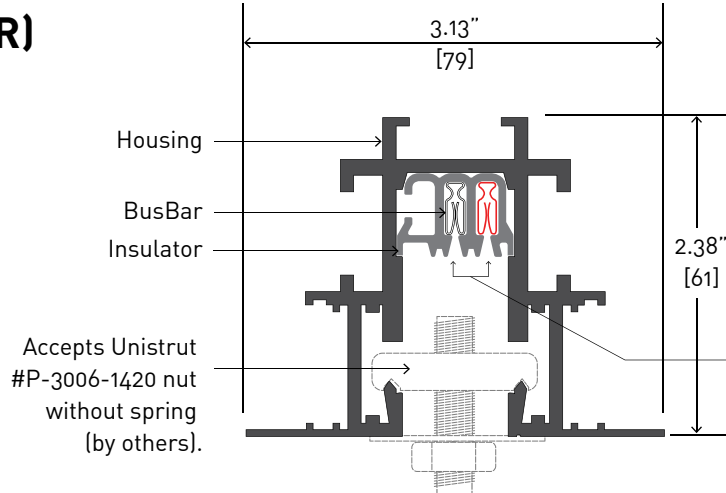
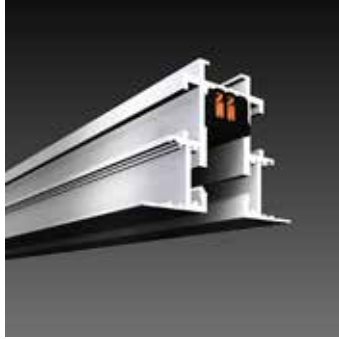

Specifications

Materials:

Extruded aluminum housing of 0.148" (3.7mm) wall thickness, with thermoplastic busbar insulator containing #6 AWG equivalent, roll-formed copper busbars.

Ratings:

Conforms to the definition of continuous plug-in busway system according to N.E.C. Article 368. UL listed for dry location, with maximum ambient temperature of 40°C (104°F.) #8 AWG leads, 60 amp maximum rated load per circuit, up to 300 volts, 5,000 AIA.

Mounting:

Mounting hardware must be specified separately. 100lb (45.4kg) maximum static load between Support points. Mounting hardware must be attached to the structure to sufficiently support load.

Vinyl/Voltage Options

- | | | | | |
|---|--|--|--|---|
| <input type="checkbox"/> 1A
BUS-11R1A
1 circ. (120V)
1-hot, 1-neutral | <input type="checkbox"/> 2A
BUS-11R2A
2 circ. (120V)
2-hot, 1-neutral | <input type="checkbox"/> 3D
BUS-11R3D
1 circ. (240V)
1-hot, 1-neutral | <input type="checkbox"/> 2D
BUS-11R2D
2 circ. (240V)
2-hot, 1-neutral | <input type="checkbox"/> 3C
BUS-11R3C
1 circ. (277V)
1-hot, 1-neutral |
| <input type="checkbox"/> 4B
BUS-11R4B
1 circ. (12V)
1-hot, 1-neutral | <input type="checkbox"/> 4K
BUS-11R4K
1 circ. (12V INT'L)
1-hot, 1-neutral | <input type="checkbox"/> 6A
BUS-11R6A
1 circ. (120V)
2-hot, 1-neutral
tied hots | <input type="checkbox"/> 6D
BUS-11R6D
1 circ. (240V)
2-hot, 1-neutral
tied hots | |

Amperage Options

- | | | | |
|---|---|---|---|
| <input type="checkbox"/> 1
16 AMP
(240V) | <input type="checkbox"/> 2
20 AMP | <input type="checkbox"/> 3
30 AMP | <input type="checkbox"/> 6
60 AMP |
|---|---|---|---|

Color Options

- | | | | | |
|--------------------------------------|-------------------------------------|--|---|---|
| <input type="checkbox"/> MB
Black | <input type="checkbox"/> P
White | <input type="checkbox"/> NT
Brushed
Aluminum | <input type="checkbox"/> UF
Unfinished
Mill | <input type="checkbox"/> CP
Custom
Finish |
|--------------------------------------|-------------------------------------|--|---|---|

Model Number Guide

To build a BusRun model number - fill in the boxes below based on your selections from above.

Example: **B U S - 1 1 R 1 A X X 6 - • M B -**

This model number represents extrusion Bus 11, a recessed mounting condition, 1-circuit-120V, 60 amps and color black.

Specify: **B U S - 1 1 R [] [] X X [] - [] • [] [] [] [] [] - [] []**

VINYL/VOLTAGE

AMPS

LENGTH IN INCHES IF KNOWN

COLOR

Extrusion Profile:

BUS-11

Mounting Condition:

Recessed (R)

T-BAR, TRIMMED

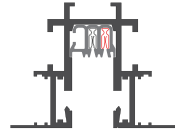

Mounting Rules

12" [300] A support point must be provided within 12" of every end or corner of the BusRun layout.

4'-0" [1220] Maximum distance between support points cannot exceed 4'-0" linear feet of 'surface' BusRun Busway.

3" [76] Support points cannot be within 3" from the centerline on both sides of BusRun joints.

100lb [45kg] BusRun Busway and mounting hardware are rated for a total supported weight up to 100lbs [45kg] between Support points.

Mounting Options

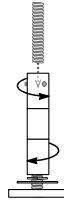

Threaded Rod Hanger

Nickel-plated counter-rotating threaded rod hanger and mounting bar enable attachment and leveling of BusRun to fixed threaded rod.

B-HH0-TR250 for 1/4-20 rod

B-HH0-TR375 for 3/8-16 rod

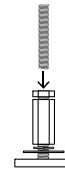

Coupling Nut for threaded rod

B-HH0-CK-M6-01 for M6 rod



Retaining Clip for ceiling system

TBC-IT-01 (included)

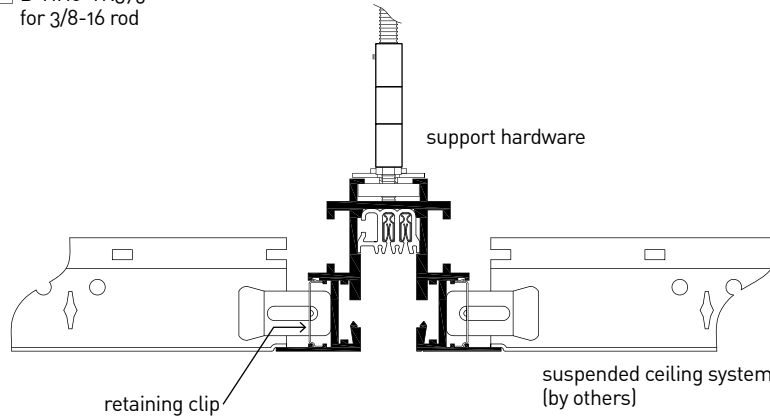

Mounting Diagram

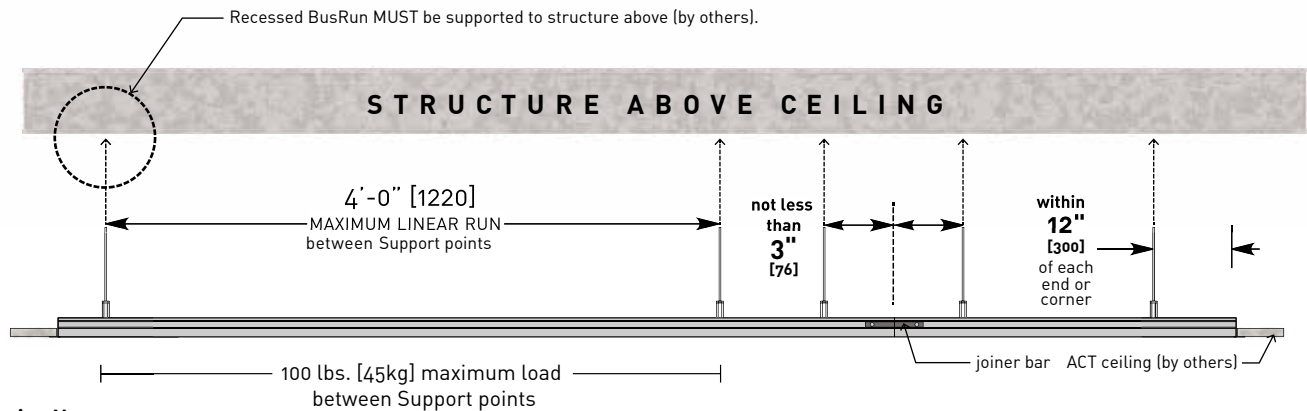

Mounting Notes:

10'-0" [3048] Recessed BusRun section requires **3** support points.

8'-0" [2438] Recessed BusRun section requires **3** support points.

4'-0" [1219] Recessed BusRun section requires **2** support points.

Extrusion Profile:

BUS-11

Mounting Condition:

Recessed (R)

T-BAR, TRIMMED

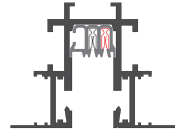

Feed Options

TEF-11R

TEC-11R (CL)



Top End Feed:
Whip Style
1/2" NPSM or 20mm
top conduit

Max Load
60 amp at 12v, 120v,
240v, 277v

TCF-11R

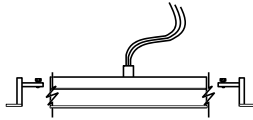

Top Center Feed:
Whip Style
1/2" NPSM or 20mm
top conduit

Max Load
60 amp at 12v, 120v,
240v, 277v

SEF-11R

SEC-11R (CL)

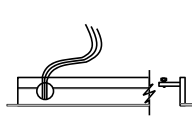

Side End Feed:
Whip Style
1/2" NPSM or 20mm
top conduit

Max Load
60 amp at 12v, 120v,
240v, 277v

SCF-11R

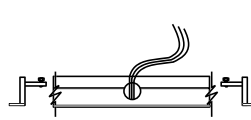

Side Center Feed:
Whip Style
1/2" NPSM or 20mm
top conduit

Max Load
60 amp at 12v, 120v,
240v, 277v

EEF-11R

EEC-11R (CL)

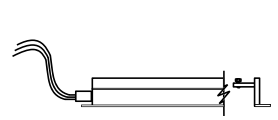

Top End Feed:
Whip Style
1/2" NPSM or 20mm
top conduit

Max Load
60 amp at 12v, 120v,
240v, 277v

TEB-11R

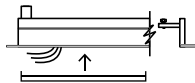

Top End Feed:
Splice Box Style
1/2" NPSM or 20mm
top conduit

Max Load
30 amp at 120v, or
16 amp at 240v

TCB-11R

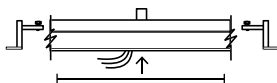

Top Center Feed:
Splice Box Style
1/2" NPSM or 20mm
top conduit

Max Load
30 amp at 120v, or
16 amp at 240v

EEB-11R

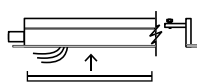

Top End Feed:
Splice Box Style
1/2" NPSM or 20mm
top conduit

Max Load
30 amp at 120v, or
16 amp at 240v

Notes:

1. All Splice Box feeds are 30 amp max load.
2. All feeds are supplied with two end caps.
3. Feeds cannot be modified.
4. Feeds can be made 10" to 120" long.
5. Maximum loads are per circuit.

Current Limiter (CL)

(120v only)

Available Amperages

1.0A	120VA
1.5A	180VA
2.0A	240VA
3.0A	360VA
4.0A	480VA
5.0A	600VA
6.0A	720VA
8.0A	960VA
12.0A	1440VA

Side View

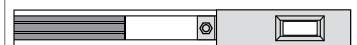

Reflected Plan View