

Job Name:

Fixture Type:

Museum Collection

LED Retrofit/Wallwash

M62MR16

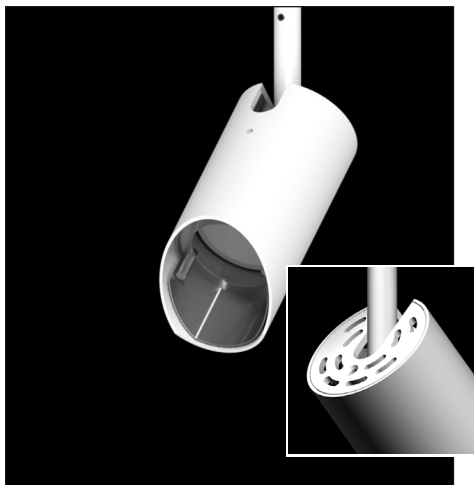
Specify:

M62MR16

FIXTURE MODEL

ADAPTER

VOLTAGE

FINISH

ACCESSORIES(optional)

Example:

M62MR16

9iC-RL

A

P

OL-5 x 30- a

Museum Collection Fixtures

MR16 LED

Ratings

- Fits deep 2.38" (60mm) BusRun.
- Fixture rotates up to 360° and may be ordered with an on/off switch. Includes standard tilt & rotation locks.
- Accessory cartridge is designed to be remounted in the same position after relamping, maintaining proper orientation of all accessories.
- Slotted back panel allows for air to pass through housing for efficient heat dissipation.

Refer to Litelab.com for tested lamps.

15 watts maximum

Features & Benefits

Flush Fit adapter with Rotation Lock*

Adapter plugs into Busway with separate electrical and mechanical connections. Integrated transformer allows for cooler fixture operation and longer lamp life. Adapter equipped with thumb wheel horizontal rotation lock.

Stem

Durable aluminum stem, features a constant tension tilt swivel that is mechanically lockable. Standard aiming angle is 90° maximum.

Lamp Housing

Housing is attached to a precision machined aluminum heatsink by means of a ball catch, allowing for one hand relamping while never changing focus or lens orientation.

Accessory Cartridge**

Front installing cartridge is equipped with a kick reflector and holds optional lenses and light blocking screens.

Lenses & Accessories**

Optional 55°x75° optical patterned wallwash spread lens, 5°x30° or 5°x55° linear spread lens available. All lenses are keyed for lockable orientation. Photo etched light blocking screens and beam softener lens are also available. Accessory size code shall be 'a.'

Finishes

Available in a durable powdercoat finish of white or matte black as well as Litelab's natural aluminum. Consult for custom finishes.

Dimming

Use ELV (electronic low voltage) rated dimmers only.

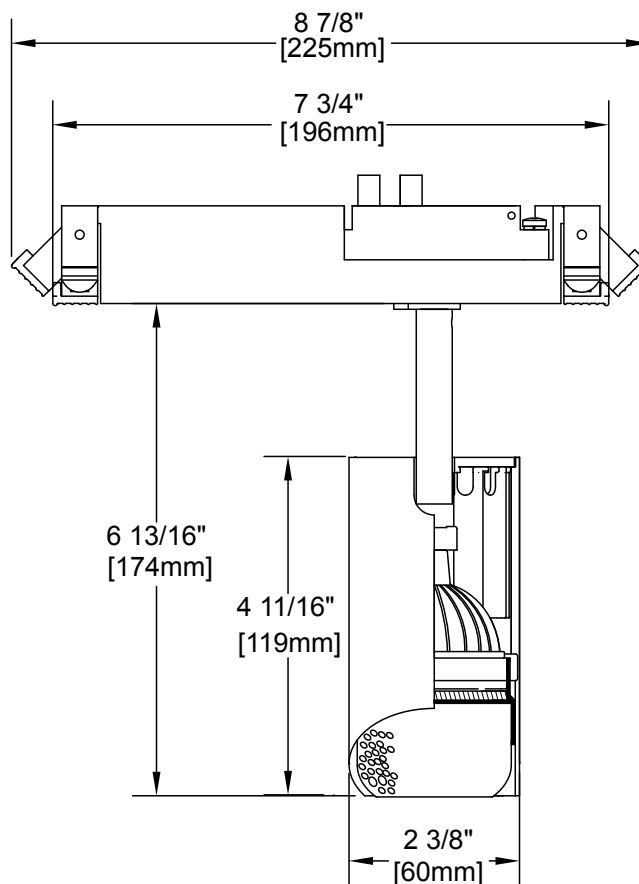

251 Elm Street Buffalo, NY 14203 USA
800-238-4120 • www.litelab.com © 11/16

*Covered under one or more of the following patents: US: 8,740,421 B2, D499, 698, D389,012, Republic of China: D149,379, People's Republic of China: ZL 201130358013.3. Additional patents pending. **See fittings and accessories page for mounting options and accessories.

ADAPTERS

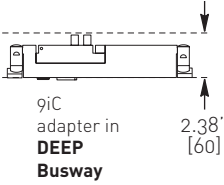
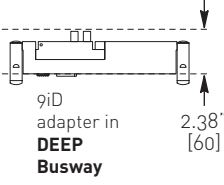
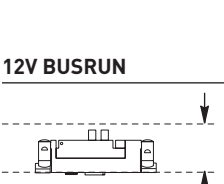
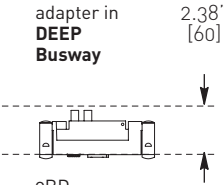
BUSRUN	adapter code	on-off switch	rotation lock	voltage
		optional	standard	
 <p>9iC adapter in DEEP Busway 2.38" [60]</p>	9iC	-SY	-RL	-A
	fused Lock n Hide fitter with integral driver for use with Deep 120V BusRun busway			
 <p>9iD adapter in DEEP Busway 2.38" [60]</p>	9iC	-SY	-RL	-D
	fused Lock n Hide fitter with integral driver for use with Deep 240V BusRun busway			
 <p>9iD adapter in DEEP Busway 2.38" [60]</p>	9iD	-SY	-RL	-A
	fused plug-in fitter with integral driver for use with Deep 120V BusRun busway			
 <p>9iD adapter in DEEP Busway 2.38" [60]</p>	9iD	-SY	-RL	-D
	fused plug-in fitter with integral driver for use with Deep 240V BusRun busway			

12V BUSRUN

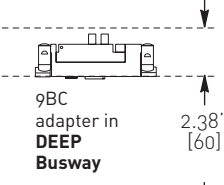
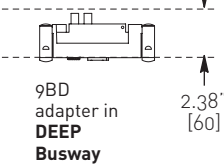
 <p>9BC adapter in DEEP Busway 2.38" [60]</p>	9BC	-SY	-RL	-B
	fused Lock n Hide fitter for use with 12V BusRun busway			
 <p>9BD adapter in DEEP Busway 2.38" [60]</p>	9BD	-SY	-RL	-B
	fused plug-in fitter for use with 12V BusRun busway			

TRACK (120V, 240V)

2-3 Circuit

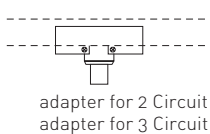

Spec Track adapter - 3.8" [97] L x 1.25" [32] W x .75" [19] Ht for use in two or three circuit track.

EUT-2
EUT-3

INPUT REQUIREMENTS

Check with LED lamp manufacturer for specific lumen/input requirements.

FITTER DETAIL HIGHLIGHTING OPTIONAL SWITCH

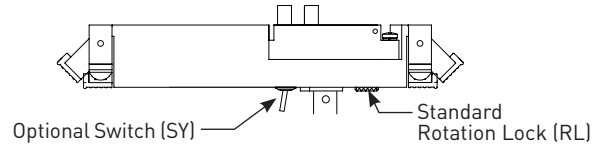

ACCESSORIES

Spread Lenses

Linear Spread
OL- 5° x 30°-a
OL- 5° x 55°-a

Universal Spread
OL- 55° x 75°-a

Beam Softener
OL-SF-a

Note: Some LED manufacturers do not recommend the use of lenses in front of their lamps. See manufacturer for details.

Screens

Light Block Screen
B-15N/a

Photo-etched, 15% light-blocking screen. Accepts up to 5 for 30%, 45%, 60% or 75% (maximum)

FINISHES

Consult with Litelab for custom finishes

NT Brushed Aluminum
MB Black
P White
CP Custom Paint

ADAPTERS

CANOPY ONLY

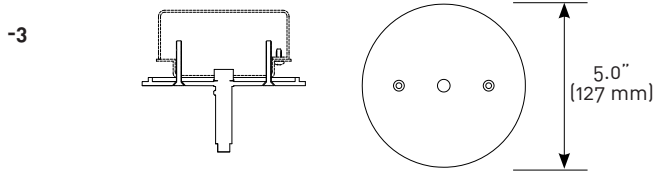

5" (127mm) diameter x 1/4" (6mm) height machined canopy for remote transformer. (Transformer required and ordered separately. Junction box not included.)

CANOPY WITH POWER SUPPLY (120V, 230V, 277V)

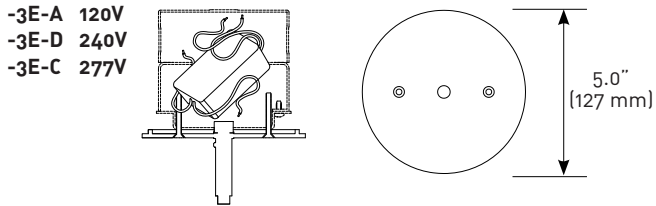

5" (127mm) diameter x 1/4" (6mm) height machined canopy with electronic low-voltage power supply. (4" x 4" x 4" junction box not included.)

BUSPOINTS

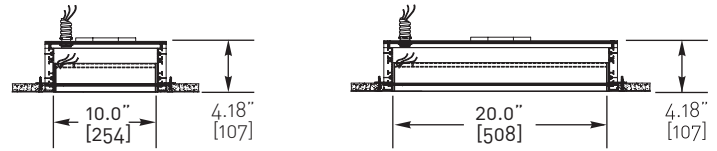

BP1-08-1A-10 120V
BP1-08-3D-10 240V

BP1-08-1A-20 120V
BP1-08-3D-20 240V

2" QUICK CONNECT CANOPY

2" canopy voltage

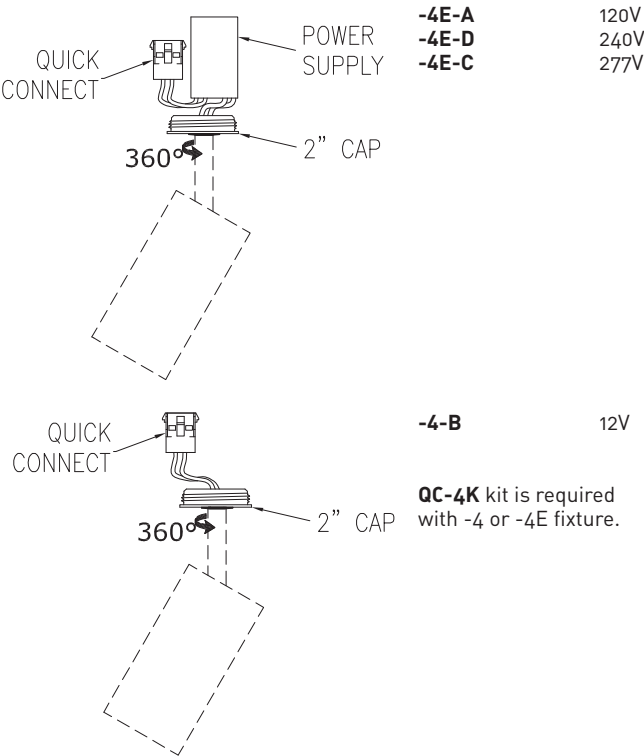

QC-4K kit is required with -4 or -4E fixture.

2" QUICK CONNECT FLANGE KIT

QC-4K kit for use with -4 or -4E fixture.

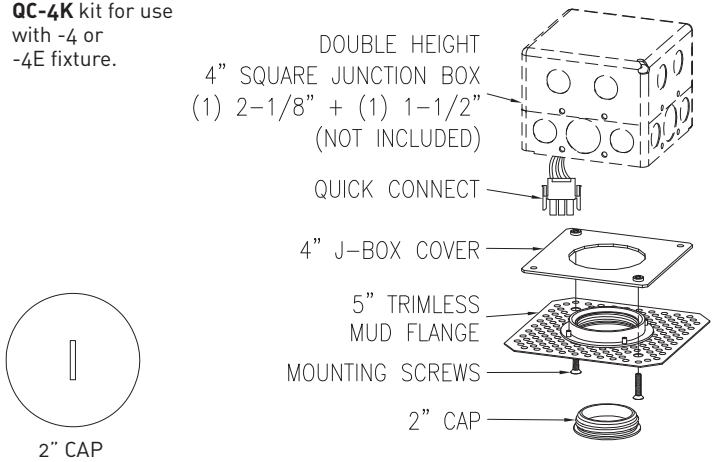

Box fill must be in compliance with National Electric Code Article 314.