

LED Wallwash

M38L1400/M38L2000



Specify:

M38 [] - [] - [] - [] - [] - [] - [] - []

FIXTURE MODEL LUMENS ADAPTER VOLTAGE CRI CCT FINISH

Example:

M38 L2000 9AC-RL A 98 30 P

This Litelab fixture features a dedicated XICATO XTM module. To specify an LED module select the lumen, CRI, and color temperature options from below and complete the model number as shown. Adapter, voltage, finish and reflector options are shown on page two.

LUMEN OPTIONS	CRI OPTION	COLOR TEMP (CCT)	INPUT REQUIREMENTS
L2000 2000Lumens	95 27	95 CRI/2700K	120VAC/0.22A/27W
	95 30	95 CRI/3000K	120VAC/0.22A/27W
	95 35	95 CRI/3500K	120VAC/0.22A/27W
L2000 2000Lumens	95 27	95 CRI/2700K	230VAC/0.11A/30W
	95 30	95 CRI/3000K	230VAC/0.11A/30W
	95 35	95 CRI/3500K	230VAC/0.11A/30W
L2000 2000Lumens	95 27	95 CRI/2700K	277VAC/0.10A/31W
	95 30	95 CRI/3000K	277VAC/0.10A/31W
	95 35	95 CRI/3500K	277VAC/0.10A/31W
L1400 1400Lumens	95 27	95 CRI/2700K	120VAC/0.15A/18W
	95 30	95 CRI/3000K	120VAC/0.15A/18W
	95 35	95 CRI/3500K	120VAC/0.15A/18W
L1400 1400Lumens	95 27	95 CRI/2700K	230VAC/0.08A/19W
	95 30	95 CRI/3000K	230VAC/0.08A/19W
	95 35	95 CRI/3500K	230VAC/0.08A/19W
L1400 1400Lumens	95 27	95 CRI/2700K	277VAC/0.07A/19W
	95 30	95 CRI/3000K	277VAC/0.07A/19W
	95 35	95 CRI/3500K	277VAC/0.07A/19W

Features & Benefits

Fixture Description

Housing is spun aluminum with perforated back cover for ventilation. Aluminum stem features lockable constant tilt swivel with 90° maximum aiming angle. Wires shall be concealed within stem. Fixture to be supplied with wallwash reflector and OL-55X75-p wallwash spread lens.

Flush Fit adapter with Rotation Lock *

Adapter plugs into Busway with separate electrical and mechanical connections. Supplied with standard thumb wheel rotation lock. An optional switch and other standard Litelab fitters are available.

Accessory Cartridge

Cartridge design allows for enhanced passive air flow around LED components. Front installed, non-rotational, wallwash cartridge allows up to three accessories—including a range of lenses and filters.

Lenses & Accessories**

Standard 55°x75° wallwash spread lens included with fixture. Photo etched light blocking screens are also available. Accessory code shall be "p."

Finishes

Available in black, white, brushed aluminum or custom finish.

Dimming

Litelab Museum line LED fixtures are provided with LED drivers suitable for trailing edge dimmers. Dimming performance may vary depending on dimmer model or system.

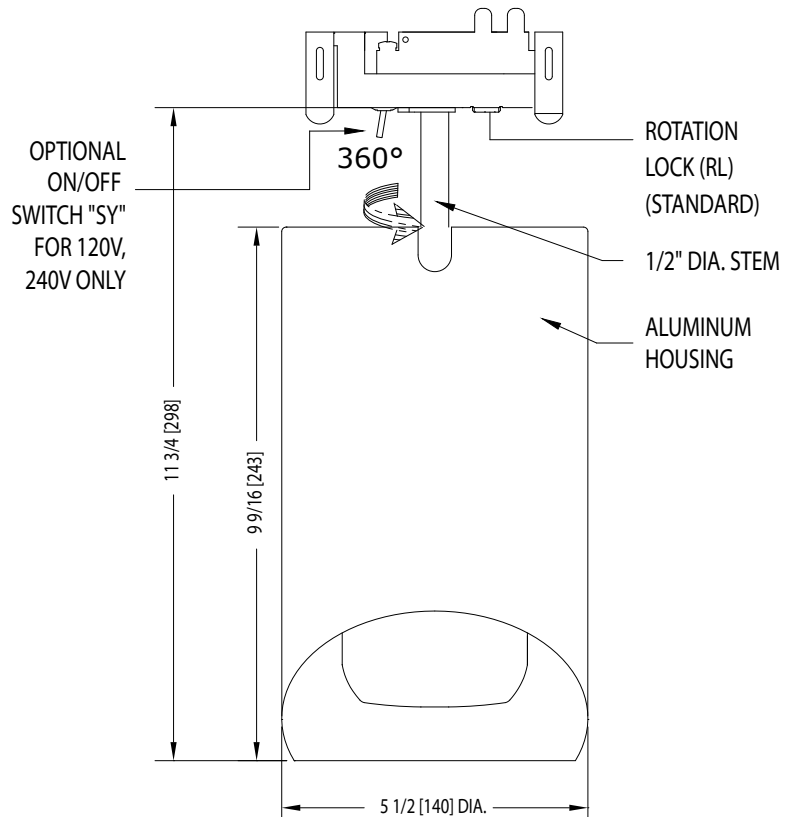

ADAPTERS

BUSRUN

	adapter code	on-off switch optional	rotation lock standard	voltage
<p>9AC adapter in DEEP Busway</p>	9AC	-SY	-RL	-A
	fused Lock n Hide fitter for use with Deep 120V BusRun busway			
<p>9AC adapter in DEEP Busway</p>	9AC	-SY	-RL	-D
	fused Lock n Hide fitter for use with Deep 240V BusRun busway			
<p>9AC adapter in DEEP Busway</p>	9AC	*	-RL	-C
	fused Lock n Hide fitter for use with Deep 277V BusRun busway			
<p>9AD adapter in DEEP Busway</p>	9AD	-SY	-RL	-A
	fused plug-in fitter for use with Deep 120V BusRun busway			
<p>9AD adapter in DEEP Busway</p>	9AD	-SY	-RL	-D
	fused plug-in fitter for use with Deep 240V BusRun busway			
<p>9AD adapter in DEEP Busway</p>	9AD	*	-RL	-C
	fused plug-in fitter for use with Deep 277V BusRun busway			

* switch available for 120V and 230V only

TRACK (120V, 240V)

2-3 Circuit

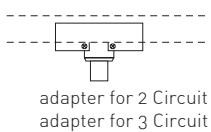

Spec Track adapter - 3.8" [97] L x 1.25" [32] W x .75" [19] Ht for use in two or three circuit track.

EUT-2
EUT-3

ACCESSORIES

Spread Lenses

Universal Spread
OL- 55° x 75°-p
(included)

Screens

Light Block Screen
B-15N/p

Photo-etched, 15% light-blocking screen. Accepts up to 5 for 30%, 45%, 60% or 75% (maximum)

FINISHES

Consult with Litelab for custom finishes

- NT** Brushed Aluminum
- MB** Black
- P** White
- CP** Custom Paint

ADAPTERS

CANOPY

-3

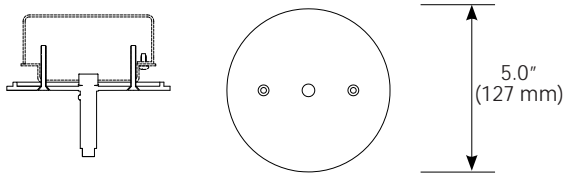

5" (127mm) diameter x 1/4" (6mm) height machined canopy. (Junction box not included.)

BUSPOINTS

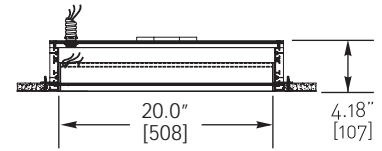
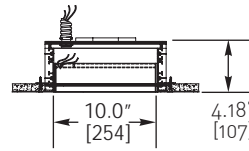

BP1-08-1A-10 120V
BP1-08-3D-10 240V
BP1-08-3C-10 277V

BP1-08-1A-20 120V
BP1-08-3D-20 240V
BP1-08-3C-20 277V

2" QUICK CONNECT CANOPY

2" canopy voltage

QUICK CONNECT

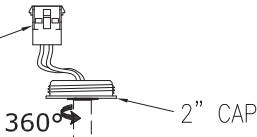

-4-A 120V
-4-D 240V

QC-4K kit is required with -4 fixture.

2" QUICK CONNECT FLANGE KIT

QC-4K kit for use with -4 fixture.

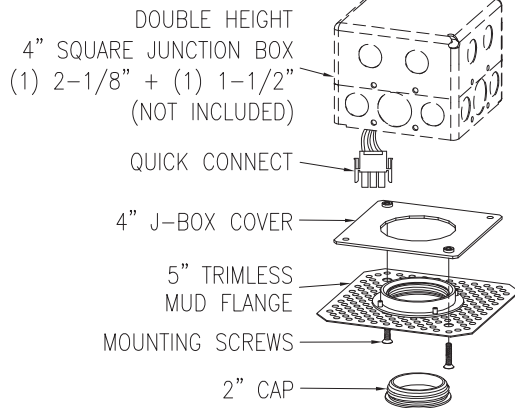
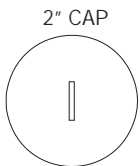

Box fill must be in compliance with National Electric Code Article 314.