

LED Wallwash

M30L1400/ M30L2000



Specify:

M30 - - - - -

FIXTURE MODEL LUMENS ADAPTER VOLTAGE CRI CCT FINISH

Example:

M30 L1300 9AC-RL A 98 30 P

This Litelab fixture features a dedicated XICATO XTM module. To specify an LED module select the lumen, CRI, and color temperature options from below and complete the model number as shown. Adapter, voltage, and finish options are shown on page two.

Features & Benefits

Fixture Description

Two-piece body style allows for high efficiency passive cooling. Housing is spun aluminum with aluminum yoke and driver housing. Wires from driver to engine shall be concealed within yoke. Fixture to be supplied with baffle/accessories holder and OL-55x75-e wallwash spread lens.

Flush Fit adapter with Rotation Lock *

Adapter plugs into Busway with separate electrical and mechanical connections. Supplied with standard thumb wheel rotation lock. An optional switch is available and other standard Litelab fitters are available.

Accessory Cartridge

Front installed, non-rotational, optical matte black cartridge allows up to three accessories—including a range of lenses, filters and louvers.

Lenses & Accessories**

Standard 55° x 75° wallwash spread lens included with fixture. Photo etched light blocking screens are also available. Accessory code shall be "e."

Finishes

Available in black, white, brushed aluminum or custom finish.

Dimming

Litelab Museum line LED fixtures are provided with LED drivers suitable for trailing edge dimmers. Dimming performance may vary depending on dimmer model or system.

LUMEN OPTIONS	CRI OPTION	COLOR TEMP (CCT)	INPUT REQUIREMENTS
L2000 2000Lumens	95 27	95 CRI/2700K	120VAC/0.22A/27W
	95 30	95 CRI/3000K	120VAC/0.22A/27W
	95 35	95 CRI/3500K	120VAC/0.22A/27W
L2000 2000Lumens	95 27	95 CRI/2700K	230VAC/0.11A/30W
	95 30	95 CRI/3000K	230VAC/0.11A/30W
	95 35	95 CRI/3500K	230VAC/0.11A/30W
L2000 2000Lumens	95 27	95 CRI/2700K	277VAC/0.10A/31W
	95 30	95 CRI/3000K	277VAC/0.10A/31W
	95 35	95 CRI/3500K	277VAC/0.10A/31W
L1400 1400Lumens	95 27	95 CRI/2700K	120VAC/0.15A/18W
	95 30	95 CRI/3000K	120VAC/0.15A/18W
	95 35	95 CRI/3500K	120VAC/0.15A/18W
L1400 1400Lumens	95 27	95 CRI/2700K	230VAC/0.08A/19W
	95 30	95 CRI/3000K	230VAC/0.08A/19W
	95 35	95 CRI/3500K	230VAC/0.08A/19W
L1400 1400Lumens	95 27	95 CRI/2700K	277VAC/0.07A/19W
	95 30	95 CRI/3000K	277VAC/0.07A/19W
	95 35	95 CRI/3500K	277VAC/0.07A/19W

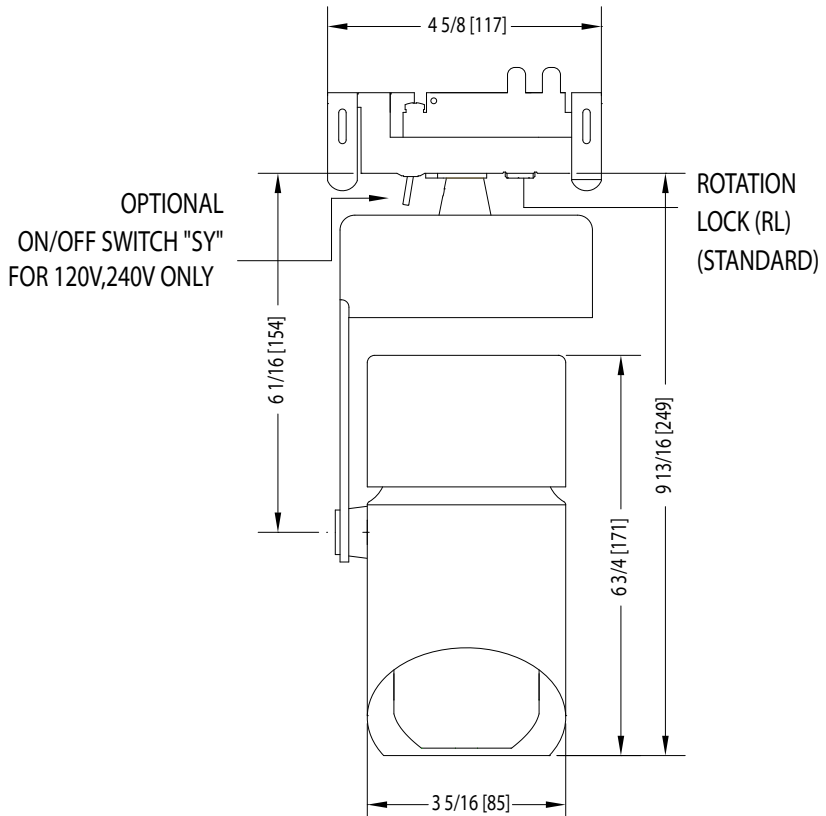

ADAPTERS

BUSRUN

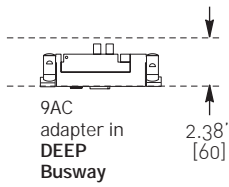

adapter code	on-off switch optional	rotation lock standard	voltage
--------------	---------------------------	---------------------------	---------

9AC	-SY	-RL	-A
------------	------------	------------	-----------

fused Lock n Hide fitter for use with **Deep 120V BusRun** busway

9AC	-SY	-RL	-D
------------	------------	------------	-----------

fused Lock n Hide fitter for use with **Deep 240V BusRun** busway

9AC	*	-RL	-C
------------	----------	------------	-----------

fused Lock n Hide fitter for use with **Deep 277V BusRun** busway

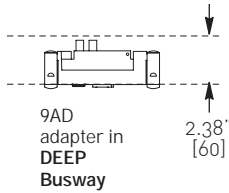

9AD	-SY	-RL	-A
------------	------------	------------	-----------

fused plug-in fitter for use with **Deep 120V BusRun** busway

9AD	-SY	-RL	-D
------------	------------	------------	-----------

fused plug-in fitter for use with **Deep 240V BusRun** busway

9AD	*	-RL	-C
------------	----------	------------	-----------

fused plug-in fitter for use with **Deep 277V BusRun** busway

* switch available for 120V and 230V only

ACCESSORIES

Spread Lenses

Universal Spread
OL- 55° x 75°-e
(included)

Screens

Light Block Screen
B-15N/e

Photo-etched,
15% light-blocking
screen. Accepts
up to 5 for 30%,
45%, 60% or 75%
(maximum)

FINISHES

Consult with Litelab
for custom finishes

- NT** Brushed Aluminum
- MB** Black
- P** White
- CP** Custom Paint

TRACK (120V, 240V)

2-3 Circuit

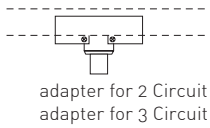

Spec Track adapter - 3.8" [97] L x 1.25" [32] W x .75" [19] Ht for use in two or three circuit track.

EUT-2
EUT-3

ADAPTERS

CANOPY

-3

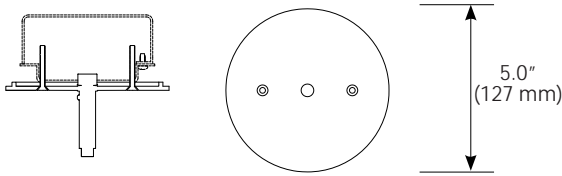

5" (127mm) diameter x 1/4" (6mm) height machined canopy. (Junction box not included.)

BUSPOINTS

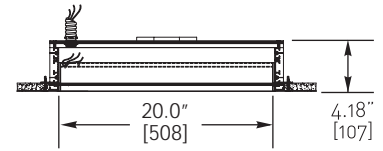
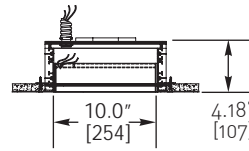

BP1-08-1A-10 120V
BP1-08-3D-10 240V
BP1-08-3C-10 277V

BP1-08-1A-20 120V
BP1-08-3D-20 240V
BP1-08-3C-20 277V

2" QUICK CONNECT CANOPY

2" canopy voltage

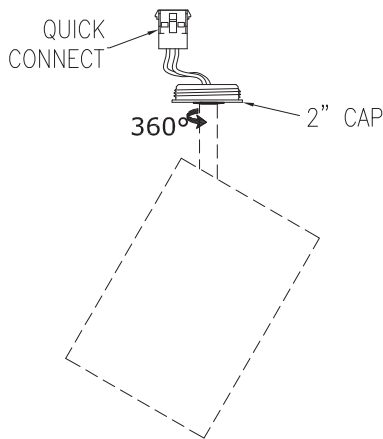

-4-A 120V
-4-D 240V

QC-4K kit is required with -4 fixture.

2" QUICK CONNECT FLANGE KIT

QC-4K kit for use with -4 fixture.

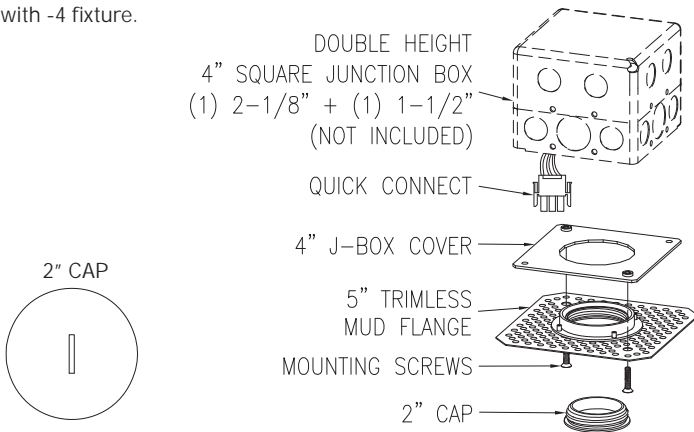

Box fill must be in compliance with National Electric Code Article 314.