

# Jewelers Collection

Job Name:

Fixture Type:

## LED Retro/Halogen

### J19MR16



Specify:

J19MR16 -  -  -  -

FIXTURE MODEL - ADAPTER - VOLTAGE - FINISH - ACCESSORIES(optional)

Example:

J19MR16 - 9iC - A - NT - OL-5 x 30- a

#### Jewelers Collection Fixtures

- Fits deep 2.38" (60mm) BusRun.
- Fixture rotates up to 360° and may be ordered with optional on/off switch.

#### Lamp

Replacement LED or 12-volt, Halogen MR-16 (by others)

#### Ratings

15 watts maximum (LED)  
50 watts maximum (Halogen)

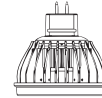

When using LED replacement lamps, performance may vary based on lamping. To ensure functionality, we recommend reviewing the performance of specified lamps with the fixture.

[Click here to review Litelab tested lamps.](#)

## Features & Benefits

#### Fixture Description

Flat front, rear-load, machined aluminum lamp ring is mounted to a precision two-way swivel.

#### Flush Fit adapter

Adapter plugs into Busway with separate electrical and mechanical connections. Integrated transformer is fully concealed in deep BusRun, and allows for cooler fixture operation and longer lamp life. An optional switch is available, or fixture may be mounted to other standard Litelab fitters.

#### Lenses and Accessories

Standard clear lenses are available with 55°x 75°, 5°x 30°, and 5°x 55° optical patterns. Beam softener lens, photo etched light blocking screens, hexcell louvers, and tapered object snouts are also available. Accessory code shall be "a".

#### Lamp Ring/Accessory Holder

Lamp ring has threaded lamp retaining ring and accepts up to two accessories.

#### Finishes

Available in brushed aluminum, black, white, or custom finish.

#### Dimming

See LED lamp manufacturer's specifications for dimming LED replacement lamps.

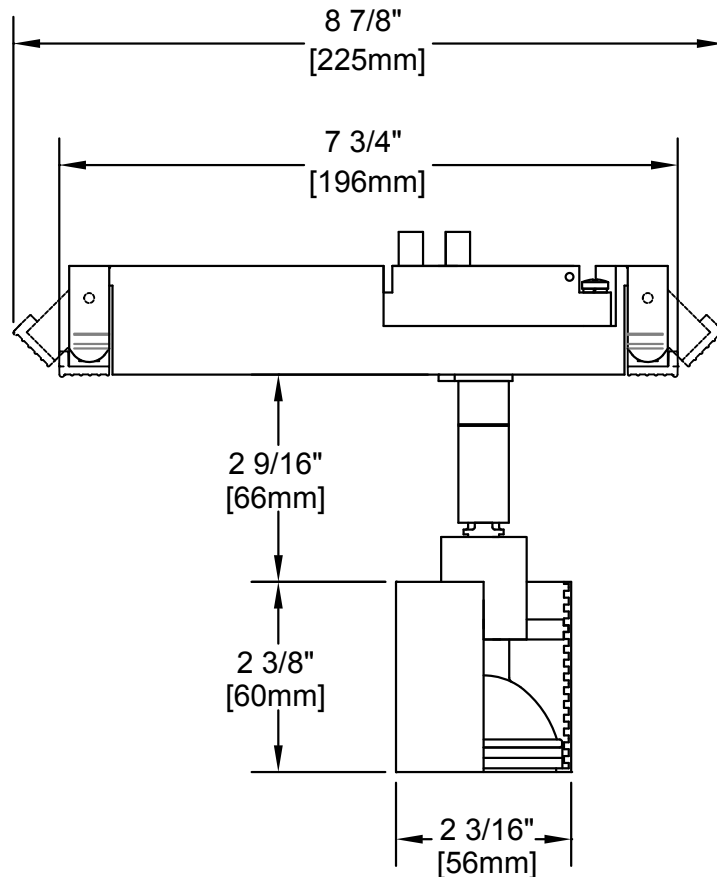

251 Elm Street Buffalo, NY 14203 USA  
800-238-4120 • www.litelab.com © 12/2016

\*Covered under one or more of the following patents: US: 8,740,421 B2, D499, 698, D389,012, Republic of China: D149,379, People's Republic of China: ZL 201130358013.3. Additional patents pending. \*\*See fittings and accessories page for mounting options and accessories.

**ADAPTERS**

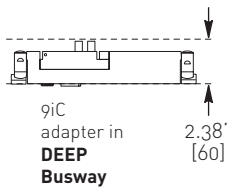
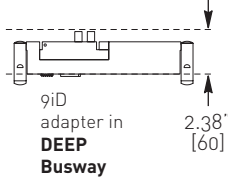
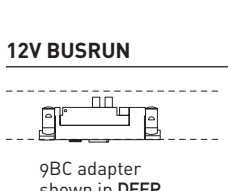
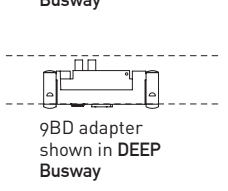
BUSRUN	adapter code	on-off switch optional	voltage
	<b>9iC</b>	<b>-SY</b>	<b>-A</b>
	fused Lock n Hide fitter with integral driver for use with <b>Deep 120V BusRun</b> busway		
	<b>9iC</b>	<b>-SY</b>	<b>-D</b>
	fused Lock n Hide fitter with integral driver for use with <b>Deep 240V BusRun</b> busway		
	<b>9iD</b>	<b>-SY</b>	<b>-A</b>
	fused plug-in fitter with integral driver for use with <b>Deep 120V BusRun</b> busway		
	<b>9iD</b>	<b>-SY</b>	<b>-D</b>
	fused plug-in fitter with integral driver for use with <b>Deep 240V BusRun</b> busway		

**12V BUSRUN**

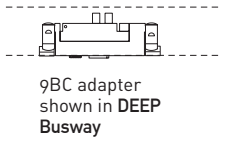
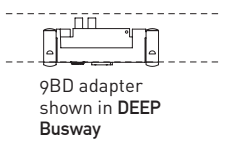
	<b>9BC</b>		<b>-B</b>
	fused Lock n Hide fitter for use with <b>12V BusRun</b> busway		
	<b>9BD</b>		<b>-B</b>
	fused plug-in fitter for use with <b>12V BusRun</b> busway		

**ACCESSORIES**

- Spread Lenses**
- Linear Spread\***  
OL- 5° x 30° - a  
OL- 5° x 55° - a
- Universal Spread\***  
OL- 55° x 75° - a
- Beam Softener\***  
OL-SF-a
- Clear Pyrex**  
OL-Flat-a (included with fixtures labeled for 50 watts)
- UV Filter**  
OL-Flat-a-UV

- Louvers & Screens**
- Hexcell Louver**  
LVH/a (black)
- Light Block Screen**  
B-15N/a
- Photo-etched, 15% light-blocking screen. Accepts up to 5 for 30%, 45%, 60% or 75% (maximum)
- Tapered Snoots**
- Object**  
SNOOT-T-a-13

**FINISHES**

- Consult with Litelab for custom finishes
- NT** Brushed Aluminum
  - MB** Black
  - P** White
  - CP** Custom Paint

**Fitter Detail**

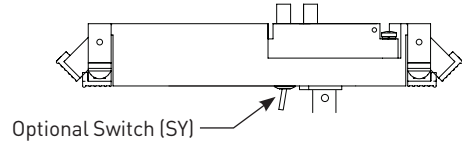

\* available with UV coating (add -UV to part number when specifying.)

**ADAPTERS**

**CANOPY ONLY**

-3

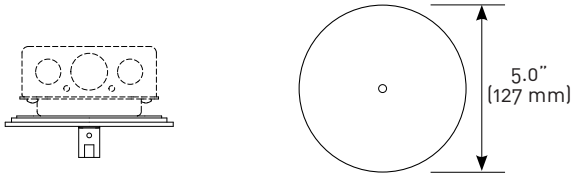

5" [127mm] diameter x 1/4" [6mm] height machined canopy for remote transformer. (Transformer ordered separately. 4" x 4" junction box not included)

**BUSPOINTS**

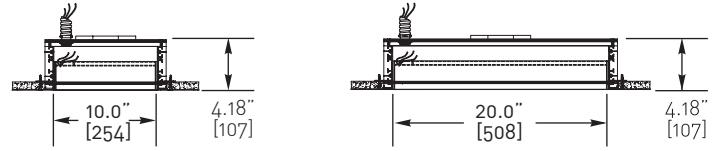

**BP1-08-1A-10** 120V  
**BP1-08-3D-10** 240V

**BP1-08-1A-20** 120V  
**BP1-08-3D-20** 240V

**CANOPY WITH POWER SUPPLY (120V, 277V, 240V)**

-3E-A 120V  
 -3E-D 240V  
 -3E-C 277V

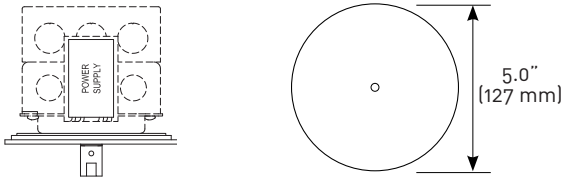

5" [127mm] diameter x 1/4" [6mm] height machined canopy with electronic low-voltage power supply. (4" x 4" x 4" junction box not included)

**2" QUICK CONNECT CANOPY**

2" canopy voltage

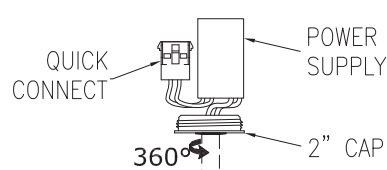

**-4E-A** 120V  
**-4E-D** 240V

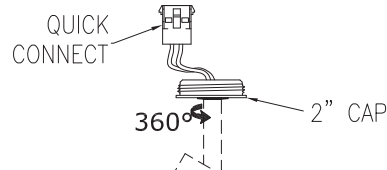

**-4-B** 12V

**QC-4K** kit is required with -4 or -4E fixture.

**2" QUICK CONNECT FLANGE KIT**

**QC-4K** kit for use with -4 or -4E fixture.

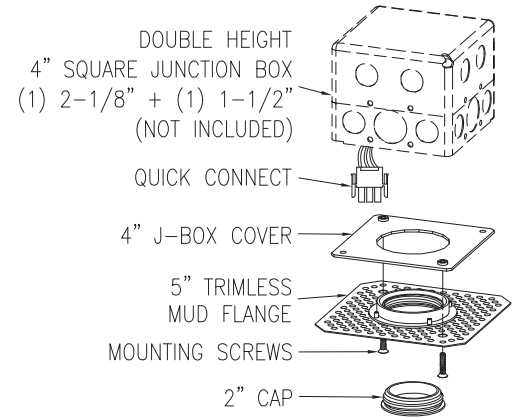

Box fill must be in compliance with National Electric Code Article 314.