

Jewelers Collection

Job Name:

Fixture Type:

Halogen

J15AR111



Specify:

J15AR111 - - - -

FIXTURE MODEL - ADAPTER - VOLTAGE - FINISH - ACCESSORIES(optional)

Example:

J15AR111 - 9iD-RL - A - NT - OL-5 x 55- s

Jewelers Collection Fixtures

- Fits deep 2.38" (60mm) BusRun.
- Fixture rotates up to 360° and may be ordered with optional on/off switch and rotation lock.

Lamp

AR111 - 12V

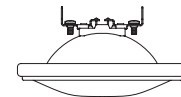

Ratings

75 watts maximum (Halogen)

For LED Retrofit lamps use our J65AR111 fixture.

Features & Benefits

Fixture Description

Yoke mounted with internally tapered, rear-load, machined aluminum lamp ring. Socket cup covers ceramic socket, and leads are enclosed in basket-weave stainless steel braiding.

Flush Fit adapter

Adapter plugs into Busway with separate electrical and mechanical connections. Integrated transformer is fully concealed in deep BusRun, and allows for cooler fixture operation and longer lamp life. Fitter options include a rotation lock and switch, or the fixture may be mounted to other standard Litelab fitters.

Lenses and Accessories

Standard clear lenses are available with 5° x 55° optical pattern. Beam softener lens, photo etched light blocking screens, hexcell louvers, and tapered object and wallwash snoots are also available. Accessory code shall be "s".

Lamp Ring/Accessory Holder

Lamp ring has threaded lamp retaining ring and accepts up to two accessories.

Finishes

Available in brushed aluminum, black, white, or custom finish.

Dimming

Use ELV (electronic low voltage) rated dimmers only.

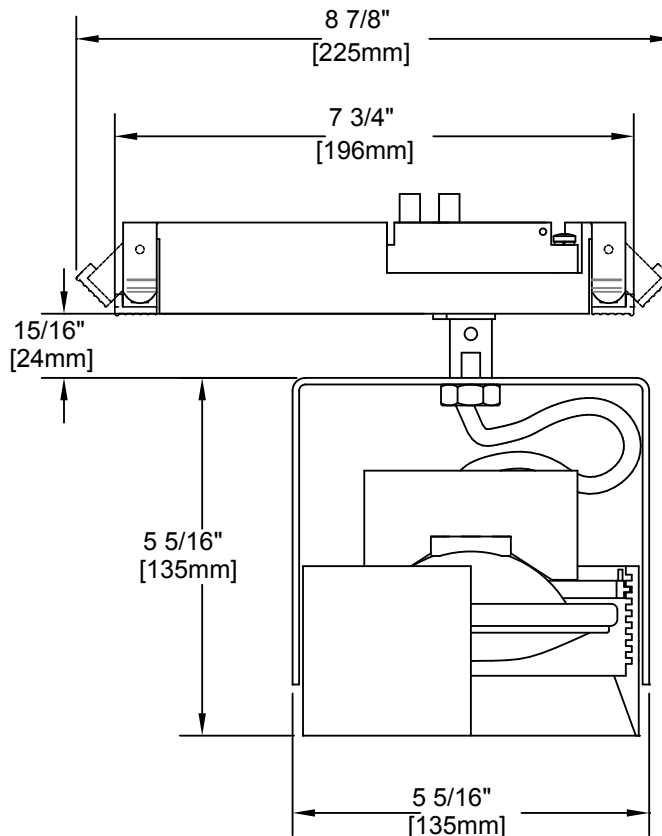

251 Elm Street Buffalo, NY 14203 USA
800-238-4120 • www.litelab.com © 12/2016

*Covered under one or more of the following patents: US: 8,740,421 B2, D499, 698, D389,012, Republic of China: D149,379, People's Republic of China: ZL 201130358013.3. Additional patents pending. **See fittings and accessories page for mounting options and accessories.

ADAPTERS

BUSRUN	adapter code	on-off switch	rotation lock	voltage
		optional	optional	

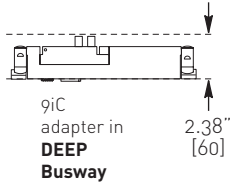

9iC -SY -RL -A
fused Lock n Hide fitter with integral driver for use with **Deep 120V BusRun** busway

9iC -SY -RL -D
fused Lock n Hide fitter with integral driver for use with **Deep 240V BusRun** busway

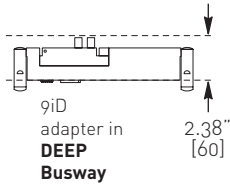

9iD -SY -RL -A
fused plug-in fitter with integral driver for use with **Deep 120V BusRun** busway

9iD -SY -RL -D
fused plug-in fitter with integral driver for use with **Deep 240V BusRun** busway

12V BUSRUN

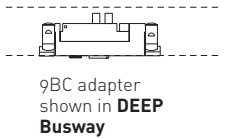

9BC -RL -B
fused Lock n Hide fitter for use with **12V BusRun** busway

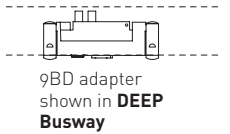

9BD -RL -B
fused plug-in fitter for use with **12V BusRun** busway

Fitter Detail

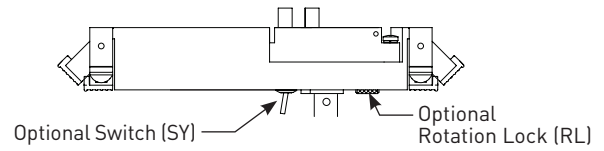

ACCESSORIES

Spread Lenses

Linear Spread*
OL-5° x 55°-s

Beam Softener*
OL-SF-s

UV Filter
OL-Flat-s-UV

* available with UV coating (add -UV to part number when specifying.)

Louvers & Screens

Hexcell Louver
LVH/s (black)

Light Block Screen
B-15N/s

Photo-etched, 15% light-blocking screen. Accepts up to 5 for 30%, 45%, 60% or 75% (maximum)

Tapered Snoots

Object
SNOOT-T-s-27

FINISHES

Consult with Litelab for custom finishes

- NT** Brushed Aluminum
- MB** Black
- P** White
- CP** Custom Paint

ADAPTERS

CANOPY ONLY

-3

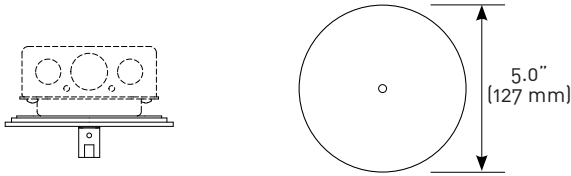

5" [127mm] diameter x 1/4" [6mm] height machined canopy for remote transformer. (Transformer ordered separately. 4" x 4" junction box not included)

BUSPOINTS

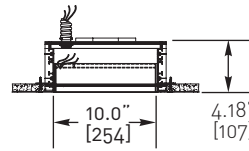

BP1-08-1A-10 120V
BP1-08-3D-10 240V

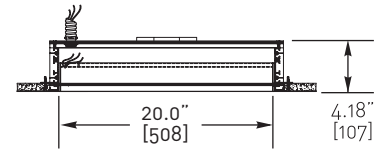

BP1-08-1A-20 120V
BP1-08-3D-20 240V

CANOPY WITH POWER SUPPLY (120V, 277V, 240V)

-3E-A 120V
 -3E-D 240V
 -3E-C 277V

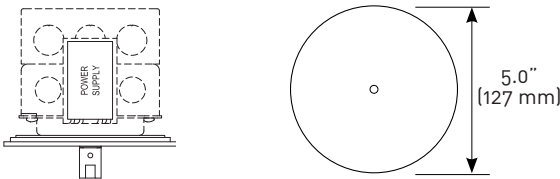

5" [127mm] diameter x 1/4" [6mm] height machined canopy with electronic low-voltage power supply. (4" x 4" x 4" junction box not included)

2" QUICK CONNECT CANOPY

2" canopy voltage

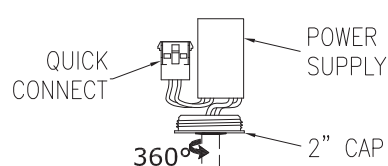

-4E-A 120V
-4E-D 240V

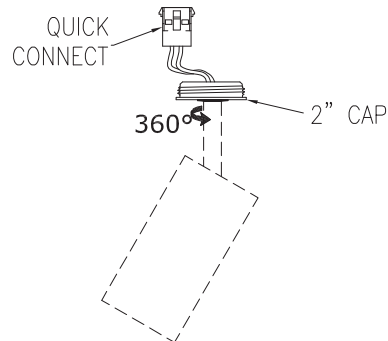

-4-B 12V

QC-4K kit is required with -4 or -4E fixture.

2" QUICK CONNECT FLANGE KIT

QC-4K kit for use with -4 or -4E fixture.

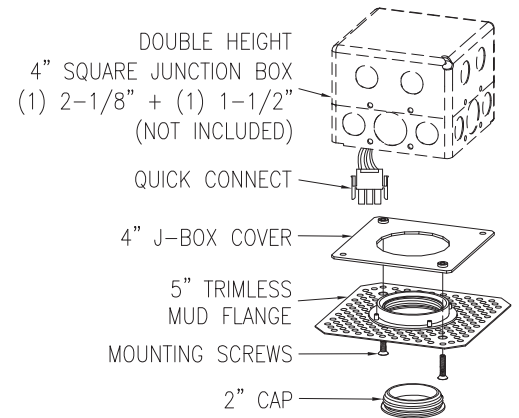

Box fill must be in compliance with National Electric Code Article 314.