

Jewelers Collection

LED Retro/Halogen

J04MR16



Job Name:

Fixture Type:

Specify:

 - - - -

FIXTURE MODEL

ADAPTER

VOLTAGE

FINISH

ACCESSORIES(optional)

Example:

 - - - -

Jewelers Collection Fixtures

- Fits deep 2.38" (60mm) BusRun.
- Fixture rotates up to 360° and may be ordered with optional on/off switch.

Lamp

Replacement LED or 12-volt, Halogen MR-16 (by others)

Ratings

15 watts maximum (LED)
50 watts maximum (Halogen)

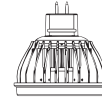

When using LED replacement lamps, performance may vary based on lamping. To ensure functionality, we recommend reviewing the performance of specified lamps with the fixture.

[Click here to review Litelab tested lamps.](#)

Features & Benefits

Fixture Description

Internally tapered, rear-load, machined aluminum lamp ring is mounted to a side-car power supply housing with a chrome-plated swivel that ensures non-drifting aiming angle up to 35°.

Flush Fit adapter

Adapter plugs into Busway with separate electrical and mechanical connections, and is fully concealed in deep BusRun. An optional switch is available, or fixture may be mounted to other standard Litelab fitters.

Lenses and Accessories

Standard clear lenses are available with 55°x 75°, 5°x 30°, and 5°x 55° optical patterns. Beam softener lens, photo etched light blocking screens, hexcell louvers, and tapered object snoots are also available. Accessory code shall be "a".

Lamp Ring / Accessory Holder

Lamp ring has threaded lamp retaining ring and accepts up to two accessories.

Finishes

Available in brushed aluminum, black, white, or custom finish.

Dimming

See LED lamp manufacturer's specifications for dimming LED replacement lamps.

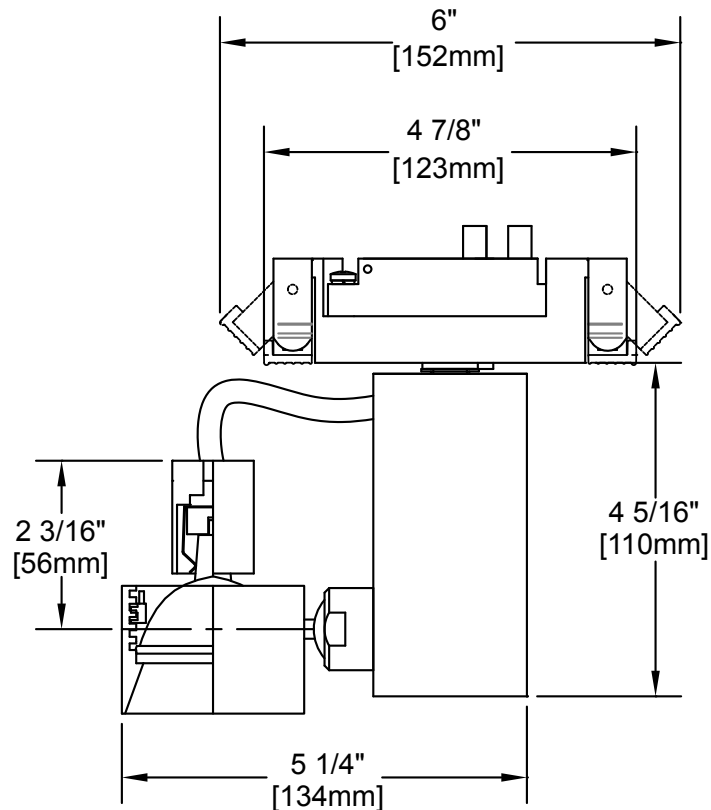

251 Elm Street Buffalo, NY 14203 USA
800-238-4120 • www.litelab.com © 12/2016

**See fittings and accessories page for mounting options and accessories.

ADAPTERS

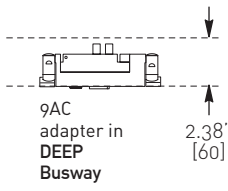
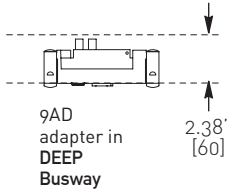
BUSRUN	adapter code	on-off switch optional	voltage
 <p>9AC adapter in DEEP Busway</p> <p>2.38" [60]</p>	9AC	-SY	-A
	fused Lock n Hide fitter with integral driver for use with Deep 120V BusRun busway		
 <p>9AD adapter in DEEP Busway</p> <p>2.38" [60]</p>	9AC	-SY	-D
	fused Lock n Hide fitter with integral driver for use with Deep 240V BusRun busway		
	9AD	-SY	-A
	fused plug-in fitter with integral driver for use with Deep 120V BusRun busway		
	9AD	-SY	-D
	fused plug-in fitter with integral driver for use with Deep 240V BusRun busway		

Fitter Detail highlighting Optional Switch

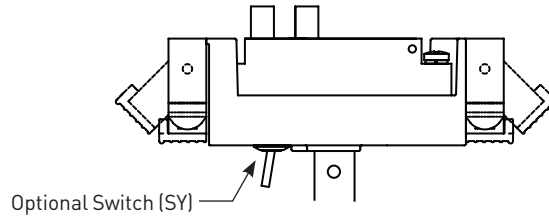

TRACK (120V, 240V)

1, 2-3 Circuit

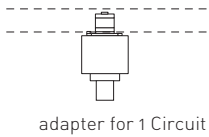

Basic Track adapter - 1.5" [38] x 1.5" [38] x 1.18" [30] Ht. for use in single circuit track.

8BT

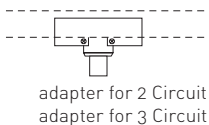

Spec Track adapter - 3.8" [97] L x 1.25" [32] W x .75" [19] Ht for use in two or three circuit track.

EUT-2
EUT-3

ACCESSORIES

Spread Lenses

Linear Spread*
OL- 5° x 30°-a
OL- 5° x 55°-a

Universal Spread*
OL- 55° x 75°-a

Beam Softener*
OL-SF-a

Clear Pyrex
OL-Flat-a (included with fixtures labeled for 50 watts)

UV Filter
OL-Flat-a-UV

* available with UV coating (add -UV to part number when specifying.)

Louvers & Screens

Hexcell Louver
LVH/a (black)

Light Block Screen
B-15N/a

Photo-etched, 15% light-blocking screen. Accepts up to 5 for 30%, 45%, 60% or 75% (maximum)

Tapered Snoot

Object
SNOOT-T-a-13

Wallwash
SNOOT-TW-a-13

FINISHES

Consult with Litelab for custom finishes

- NT Brushed Aluminum
- MB Black
- P White
- CP Custom Paint



Job Name:

Fixture Type:

ADAPTERS

CANOPY ONLY

-3

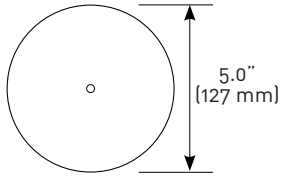
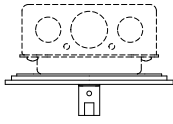

5" (127mm) diameter x 1/4" (6mm) height machined canopy. (Junction box and raised mud ring not included.)

BUSPOINTS

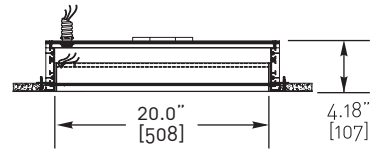
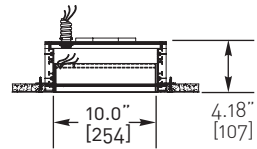

BP1-08-1A-10 120V
BP1-08-3D-10 240V

BP1-08-1A-20 120V
BP1-08-3D-20 240V