

# Busports

## Busport Receptacle Plates

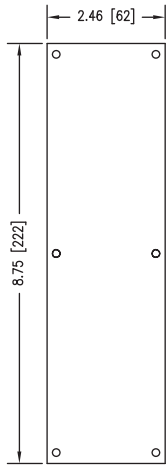

TR3 Busport



TRP-Blank



TR3-01 Junior Busport

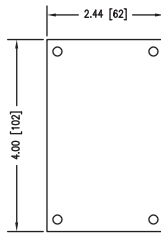

TRP-J-Blank



TR3-02 Video Busport

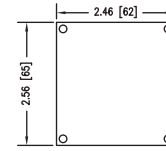

TRP-V-Blank

### Design Guidelines

1. Either chamber may be used for line (mains) or low voltage as required by design considerations. Do not mix line (mains) and low voltage in the same chamber without the approval of the local authority having jurisdiction.
2. Installer must ensure proper ground connections at time of assembly.
3. Standard Busport is provided with two blank plates. See plate options shown here for common cutout layouts, available separately. Custom plate layouts are available upon request.
4. Devices assembled to cover plates must not protrude from the surface of the plate more than 0.25" (6.4mm) or they will interfere with the vertical motion of the column. Refer to section drawing.
5. Each Busport wiring chamber is fed through a 3/4" electrical trade size flexible metallic conduit (USNECS) and associated fittings. Busports may also be ordered with standard 25mm adapters. Installer shall provide any additional or conversion hardware required for proper installation.
6. The device as provided is listed for North American use by Intertek Testing Services (ETL) and for worldwide use by TUV.

### Section View of Busport showing Volumes and Clearances

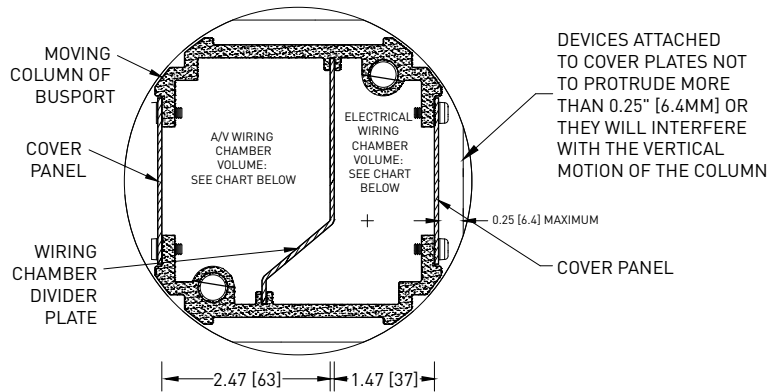

	WIRING CHAMBER VOLUMES	
	CUBIC INCHES (CC)	
	A/V	ELECTRICAL
TR3	112 (1835)	78.8 (1291)
TR3-01	79.3 (1299)	54.1 (886)
TR3-02	54.9 (900)	37.5 (614)



# 120V Receptacle Plates

Job Name:

Fixture Type:

## TR3 Busport Plates

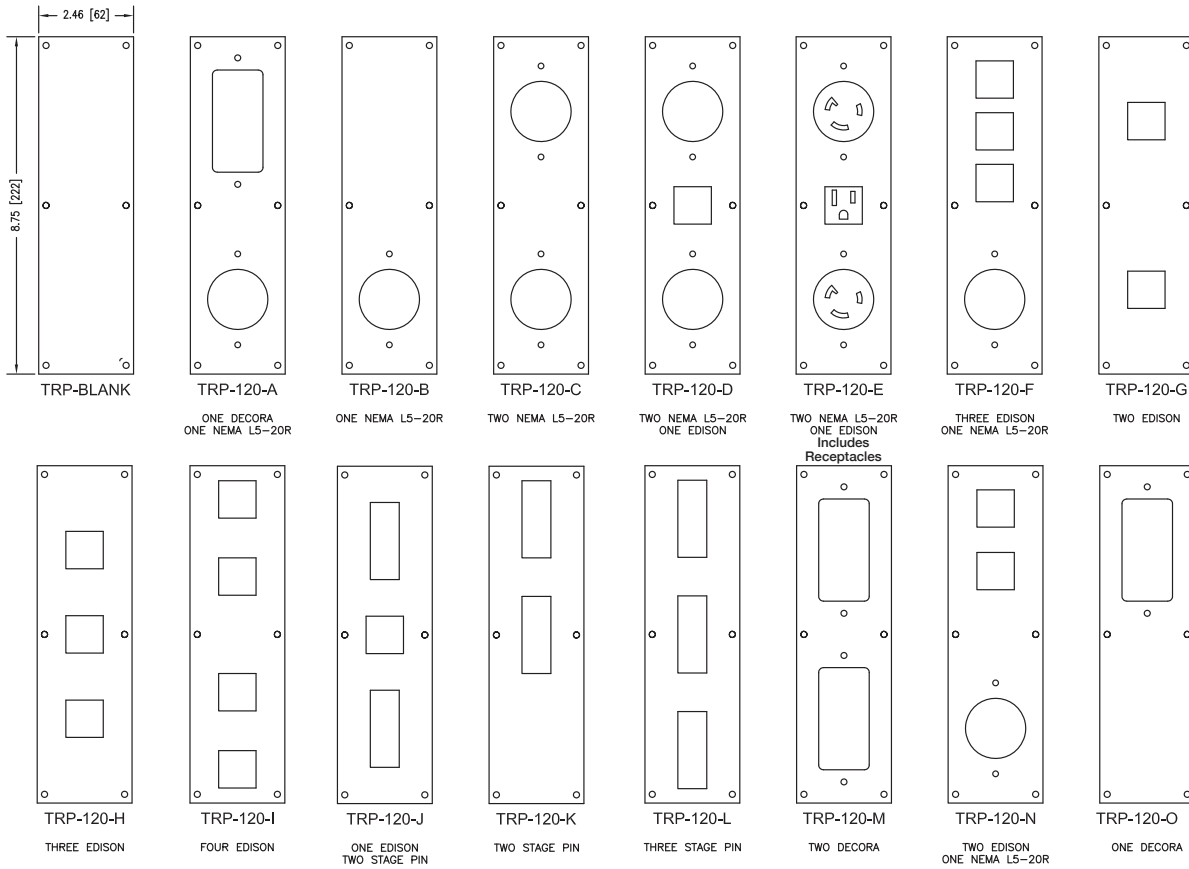

## TR3-01 Junior Busport Plates

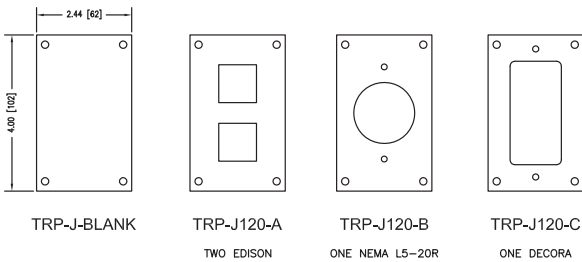

## TR3-02 Video Busport Plates

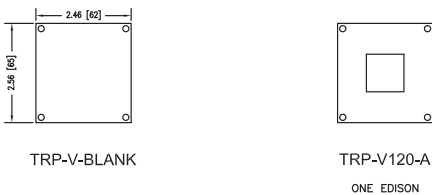

## 240V Receptacle Plates

Job Name:

Fixture Type:

## TR3 Busport Plates

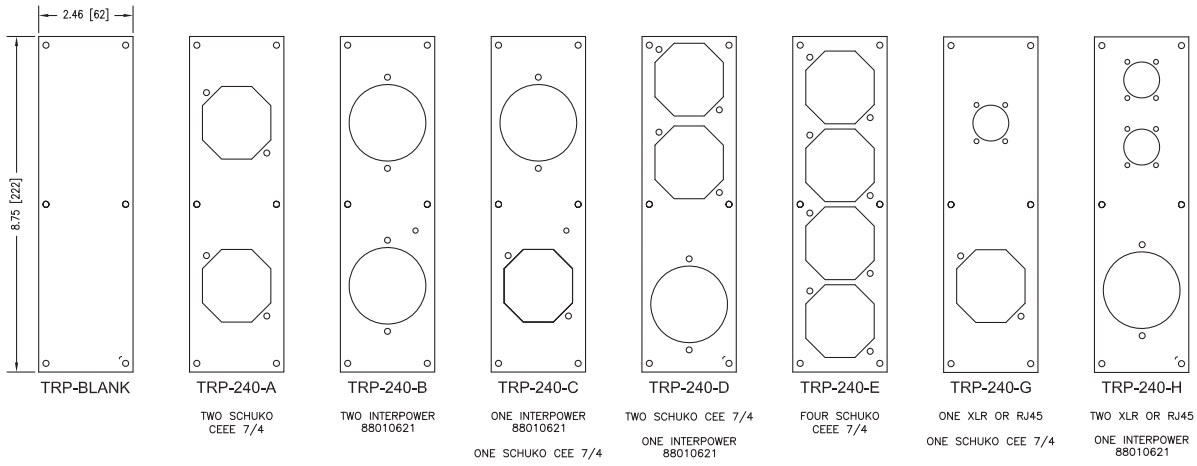

## TR3-01 Junior Busport Plates

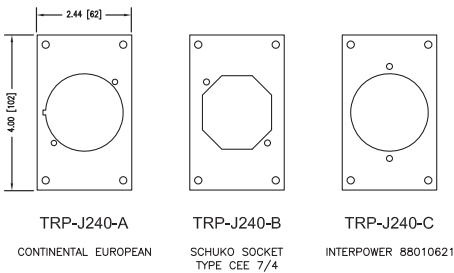

## TR3-02 Video Busport Plates

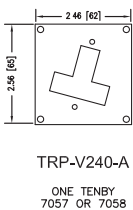

# Data Receptacle Plates

Job Name:

Fixture Type:

## TR3 Busport Plates

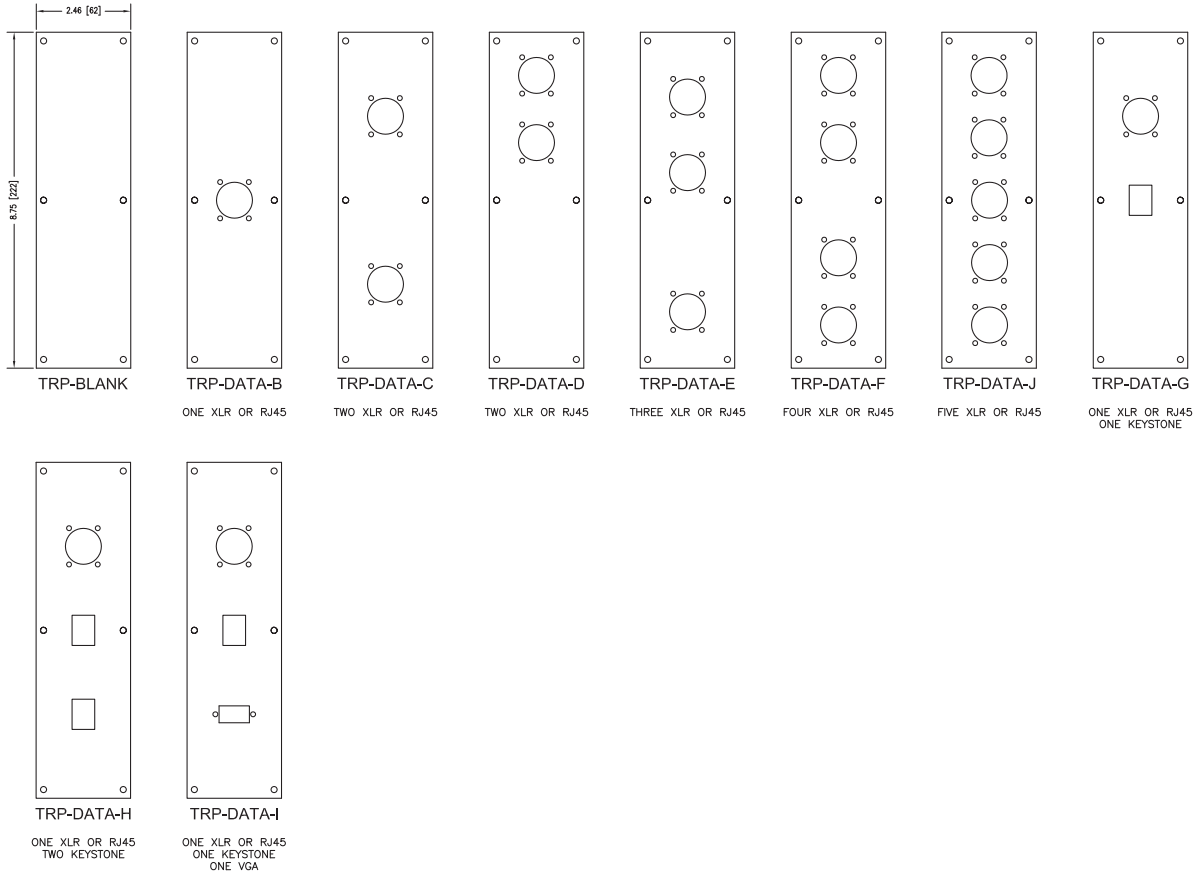

## TR3-01 Junior Busport Plates

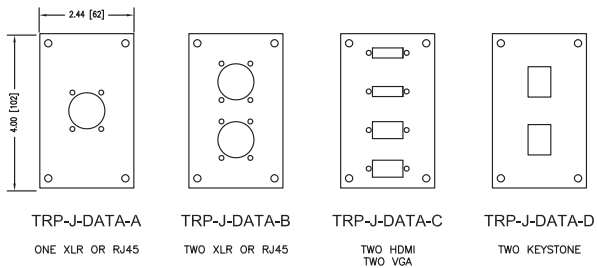

## TR3-02 Video Busport Plates

