

Extrusion Profile:  
**BUS-20**

Mounting Condition:  
**Hanging (H)**

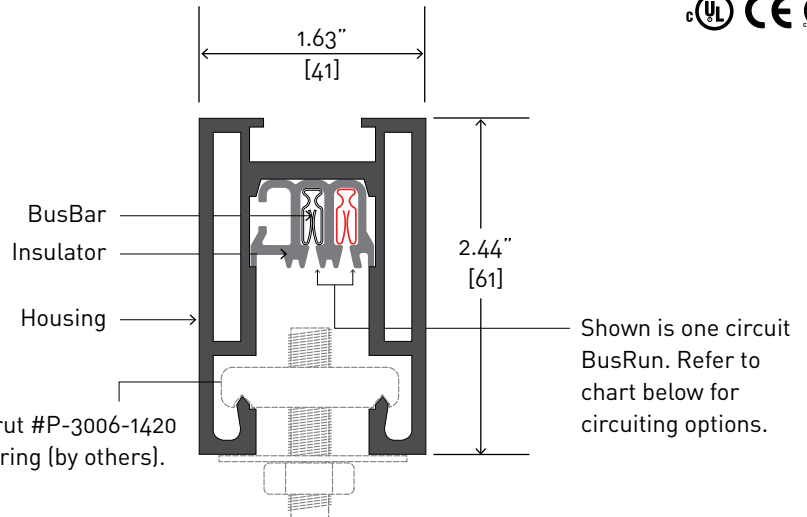

**Specifications**

**Materials:**

Extruded aluminum housing of 0.148" (3.7mm) wall thickness, with thermoplastic busbar insulator containing #6 AWG equivalent, roll-formed copper busbars.

**Ratings:**

Conforms to the definition of continuous plug-in busway system according to N.E.C. Article 368. UL listed for dry location, with maximum ambient temperature of 40°C (104°F.) #8 AWG leads, 60 amp maximum rated load per circuit, up to 300 volts, 5,000 AIA.

**Mounting:**

Mounting hardware must be specified separately. 100lb (45.4kg) maximum static load between Support points. Mounting hardware must be attached to the structure to sufficiently support load.

**Vinyl/Voltage Options**

<input type="checkbox"/> <b>1A</b> <b>BUS-20H1A</b> 1 circ. (120V) 1-hot, 1-neutral 	<input type="checkbox"/> <b>2A</b> <b>BUS-20H2A</b> 2 circ. (120V) 2-hot, 1-neutral 	<input type="checkbox"/> <b>3D</b> <b>BUS-20H3D</b> 1 circ. (240V) 1-hot, 1-neutral 	<input type="checkbox"/> <b>2D</b> <b>BUS-20H2D</b> 2 circ. (240V) 2-hot, 1-neutral 	<input type="checkbox"/> <b>3C</b> <b>BUS-20H3C</b> 1 circ. (277V) 1-hot, 1-neutral 
<input type="checkbox"/> <b>4B</b> <b>BUS-20H4B</b> 1 circ. (12V) 1-hot, 1-neutral 	<input type="checkbox"/> <b>4K</b> <b>BUS-20H4K</b> 1 circ. (12V INT'L) 1-hot, 1-neutral 			

**Amperage Options**

<input type="checkbox"/> <b>1</b> <b>16 AMP</b> (240V)	<input type="checkbox"/> <b>2</b> <b>20 AMP</b>	<input type="checkbox"/> <b>3</b> <b>30 AMP</b>	<input type="checkbox"/> <b>6</b> <b>60 AMP</b>
--	--	--	--

**Color Options**

<input type="checkbox"/> <b>MB</b> Black	<input type="checkbox"/> <b>P</b> White	<input type="checkbox"/> <b>NT</b> Brushed Aluminum	<input type="checkbox"/> <b>UF</b> Unfinished Mill	<input type="checkbox"/> <b>CP</b> Custom Finish
---	--	--	---	---

**Model Number Guide**

To build a BusRun model number - fill in the boxes below based on your selections from above.

Example: **B U S - 2 0 H 1 A X X 6 - . M B -**

*This model number represents extrusion Bus 20, a hanging mounting condition, 1-circuit-120V, 60 amps and color black.*

Specify: **B U S - 2 0 H [ ] [ ] X X [ ] [ ] - . [ ] [ ] [ ] [ ] [ ] [ ] [ ] - [ ] [ ] [ ] [ ]**

VINYL/VOLTAGE

AMPS

LENGTH IN INCHES IF KNOWN

COLOR

Extrusion Profile: **BUS-20** | Mounting Condition: **Hanging (H)**

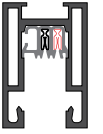

## Mounting Rules

- 12" [300]** A hang-point must be provided within 12" of every end or corner of the BusRun layout.
- 10'-0" [3050]** Maximum distance between hang-points cannot exceed 10'-0" linear feet of 'hanging' BusRun Busway.
- 14" [350]** Support points cannot be within 7" from the centerline on both sides of sleeved joints.
- 100lb [45kg]** BusRun Busway and mounting hardware are rated for a total supported weight up to 100lbs [45kg] between Support points.

## Hanging Options

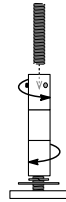

**Threaded Rod Hanger**

Nickel-plated counter-rotating threaded rod hanger and mounting bar enable attachment and leveling of BusRun to fixed threaded rod.

- B-HH0-TR250 for 1/4-20 rod
- B-HH0-TR375 for 3/8-16 rod



**LevelGlide™**  
Gripper cable with closed eyeloop

Cable with thimble, crimped loop at top, self-locking gripper and mounting bar at bottom, provide instant and precise height adjustability.

- B-HC0-060 5' [1525]
- B-HC0-120 10' [3050]
- B-HC0-180 15' [4525]

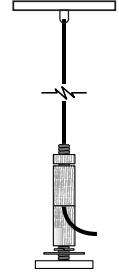

**Canopy LevelGlide™**  
Gripper, cable, and canopy

Cable with swivel coupler at top, self-locking gripper and mounting bar at bottom, provide instant and precise height adjustability. 5" dia canopy mounts to ceiling.

- B-HC0-060-C 5'
- B-HC0-120-C 10'
- B-HC0-180-C 15'

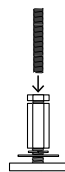

**Coupling Nut**  
for threaded rod

- B-HH0-CK-M6-01 for M6 rod

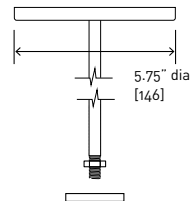

**Support Pendant**

5.75" canopy, stem and hex nut. Mounting bar supplied. Provides 18" height between bottom of Bus and ceiling.

- B-HP0D-18 18" [457]

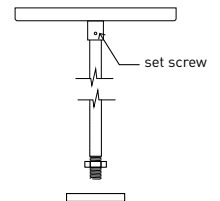

**Field Cuttable Support Pendant**

5.0" canopy, stem and hex nut. Mounting bar supplied. Stem is field cuttable and secured with set screw at canopy.

- B-HPO-24-FC 2' [600]
- B-HPO-48-FC 4' [1200]

## Mounting Diagram

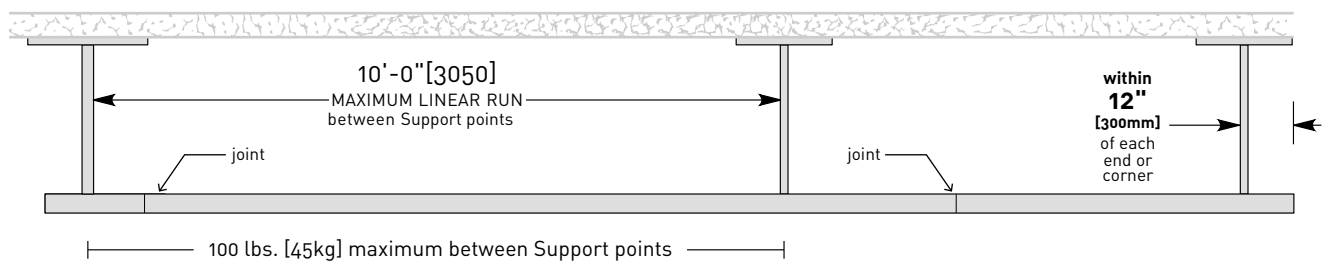

Extrusion Profile:

**BUS-20**

Mounting Condition:

**Hanging (H)**

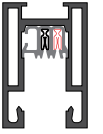

## Feed Options

- TEF-20H  
 TEC-20H (CL)

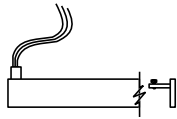

Top End Feed:  
Whip Style  
1/2" NPSM or 20mm  
top conduit

**Max Load**  
60 amp at 12v, 120v,  
240v, 277v

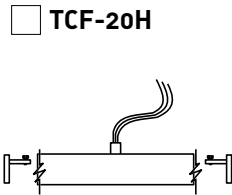

Top Center Feed:  
Whip Style  
1/2" NPSM or 20mm  
top conduit

**Max Load**  
60 amp at 12v, 120v,  
240v, 277v

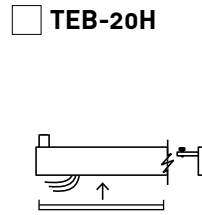

Top End Feed:  
Splice Box Style  
1/2" NPSM or 20mm  
top conduit

**Max Load**  
30 amp at 120v, or  
16 amp at 240v

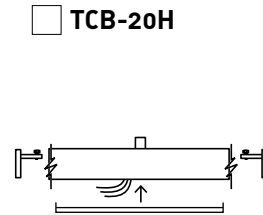

Top Center Feed:  
Splice Box Style  
1/2" NPSM or 20mm  
top conduit

**Max Load**  
30 amp at 120v, or  
16 amp at 240v

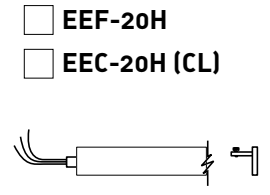

End End Feed:  
Whip Style  
1/2" NPSM or 20mm  
end conduit

**Max Load**  
60 amp at 12v, 120v,  
240v, 277v

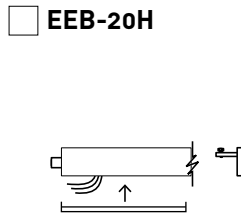

End End Feed:  
Splice Box Style  
1/2" NPSM or 20mm  
end conduit

**Max Load**  
30 amp at 120v, or  
16 amp at 240v

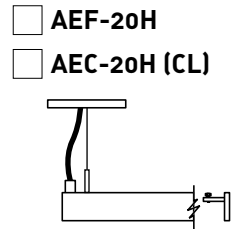

Top End Feed:  
Cable Style  
5.0" dia canopy

**Max Load**  
20 amp at 120v, or  
16 amp at 240v

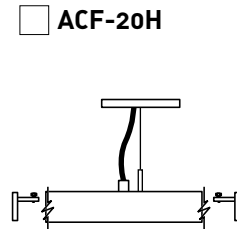

Top Center Feed:  
Cable Style  
5.0" dia canopy

**Max Load**  
20 amp at 120v, or  
16 amp at 240v

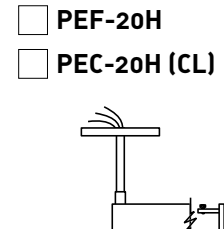

Pendant End Feed:  
6.75" dia canopy  
1/2" NPSM pendant

**Max Load**  
60 amp at 12v, 120v,  
240v, 277v

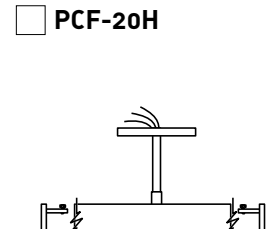

Pendant Center Feed:  
6.75" dia canopy  
1/2" NPSM pendant

**Max Load**  
60 amp at 12v, 120v,  
240v, 277v

- MEF-20H  
 MEC-20H (CL)

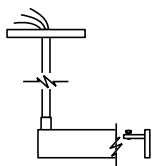

Field Cuttable  
Pendant End Feed:  
5.0" dia canopy  
1/2" pendant

**Max Load**  
60 amp at 12v, 120v,  
240v, 277v

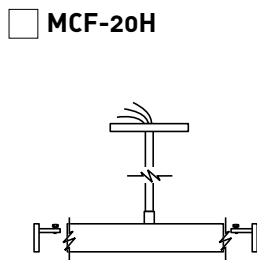

Field Cuttable  
Pendant Center Feed:  
5.0" dia canopy  
1/2" pendant

**Max Load**  
60 amp at 12v, 120v,  
240v, 277v

### Notes:

1. All Splice Box feeds are 30 amp max load.
2. All feeds are supplied with two end caps.
3. Feeds cannot be modified.
4. Feeds can be made 10" to 120" long.

### Current Limiter (CL)

(120v only)

#### Available Amperages

1.0A	120VA
1.5A	180VA
2.0A	240VA
3.0A	360VA
4.0A	480VA
5.0A	600VA
6.0A	720VA
8.0A	960VA
12.0A	1440VA

Side View

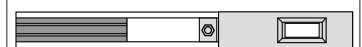

Reflected Plan View