

Extrusion Profile:
BUS-13

Mounting Condition:
Recessed (R)
D-BAR, TRIMLESS

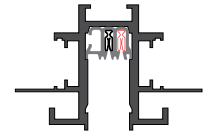

Mounting Rules

12" [300] A support point must be provided within 12" of every end or corner of the BusRun layout.

4'-0" [1220] Maximum distance between support points cannot exceed 4'-0" linear feet of 'surface' BusRun Busway

3" [76] Support points cannot be within 3" from the centerline on both sides of BusRun joints.

100lb [45kg] BusRun Busway and mounting hardware are rated for a total supported weight up to 100lbs [45kg] between Support points.

Mounting Options

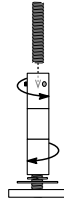

Threaded Rod Hanger

Nickel-plated counter-rotating threaded rod hanger and mounting bar enable attachment and leveling of BusRun to fixed threaded rod.

B-HH0-TR250 for 1/4-20 rod

B-HH0-TR375 for 3/8-16 rod

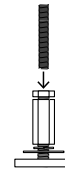

Coupling Nut for threaded rod

B-HH0-CK-M6-01 for M6 rod



Retaining Clip for ceiling system

TBC-IT-01 (ordered separately)

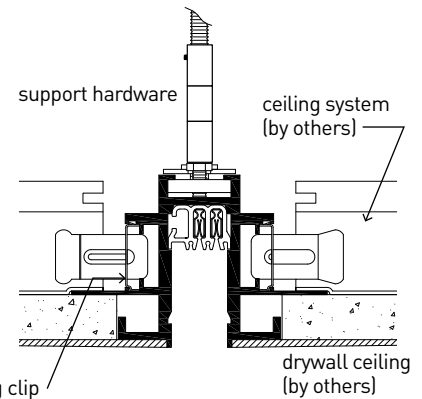
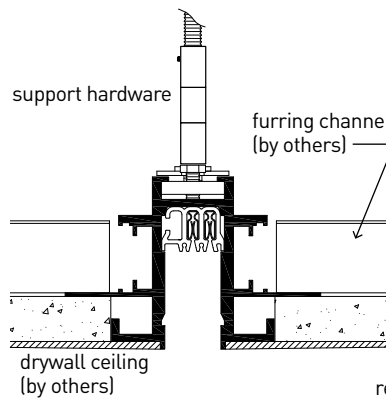

Mounting Diagram

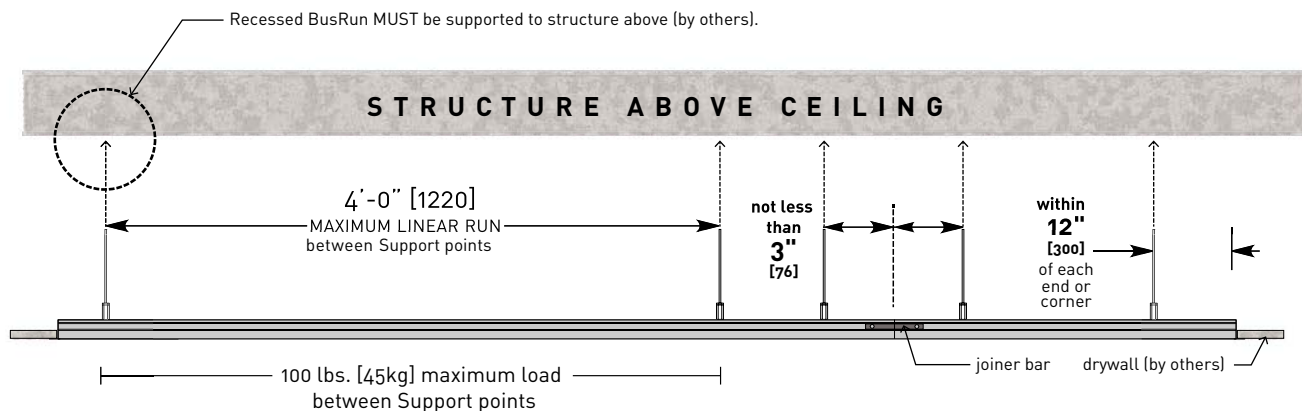

Mounting Notes:

10'-0" [3048] Recessed BusRun section requires **3** support points.

8'-0" [2438] Recessed BusRun section requires **3** support points.

4'-0" [1219] Recessed BusRun section requires **2** support points.

Extrusion Profile:

BUS-13

Mounting Condition:

Recessed (R)

D-BAR, TRIMLESS

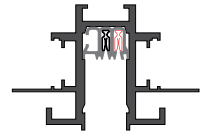

Feed Options

TEF-13R

TEC-13R (CL)



Top End Feed:
Whip Style
1/2" NPSM or 20mm
top conduit

Max Load
60 amp at 12v, 120v,
240v, 277v

TCF-13R

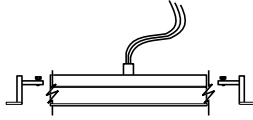

Top Center Feed:
Whip Style
1/2" NPSM or 20mm
top conduit

Max Load
60 amp at 12v, 120v,
240v, 277v

SEF-13R

SEC-13R (CL)

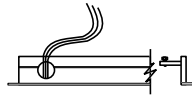

Side End Feed:
Whip Style
1/2" NPSM or 20mm
top conduit

Max Load
60 amp at 12v, 120v,
240v, 277v

SCF-13R

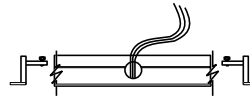

Side Center Feed:
Whip Style
1/2" NPSM or 20mm
top conduit

Max Load
60 amp at 12v, 120v,
240v, 277v

EEF-13R

EEC-13 R (CL)

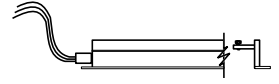

Top End Feed:
Whip Style
1/2" NPSM or 20mm
top conduit

Max Load
60 amp at 12v, 120v,
240v, 277v

TEB-13R

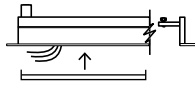

Top End Feed:
Splice Box Style
1/2" NPSM or 20mm
top conduit

Max Load
30 amp at 120v, or
16 amp at 240v

TCB-13R

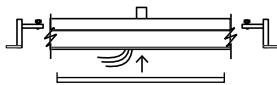

Top Center Feed:
Splice Box Style
1/2" NPSM or 20mm
top conduit

Max Load
30 amp at 120v, or
16 amp at 240v

Notes:

1. All Splice Box feeds are 30 amp max load.
2. All feeds are supplied with two end caps.
3. Feeds cannot be modified.
4. Feeds can be made 10" to 120" long.
5. Maximum loads are per circuit.

Current Limiter (CL)

(120v only)

Available Amperages

1.0A	120VA
1.5A	180VA
2.0A	240VA
3.0A	360VA
4.0A	480VA
5.0A	600VA
6.0A	720VA
8.0A	960VA
12.0A	1440VA

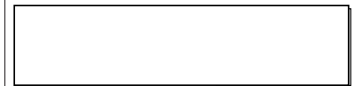

Side View

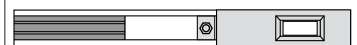

Reflected Plan View