

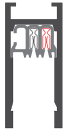

Extrusion Profile: **BUS-08** | Mounting Condition: **Wall (W)**



**Mounting Rules**

**12"** [300] A support point must be provided within 12" of every end or corner of the BusRun layout.

**3'-0"** [915] Maximum distance between support points cannot exceed 3'-0" linear feet of 'surface' BusRun Busway.

**3"** [76] Support points cannot be within 3" from the centerline on both sides of BusRun joints.

**100lb** [45kg] BusRun Busway and mounting hardware are rated for a total supported weight up to 100lbs [45kg] between Support points.

**Mounting Options**

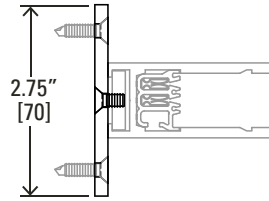

**Wall Mount Bar**

Aluminum bracket attaches to BusRun top channel 7/8" x 2.75" [23x70] Maximum spacing 3'-0" [915].

40130 – for One Channel Bus

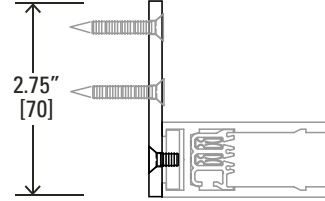

**Horizontal Wall Mount Bar**

Aluminum bracket attaches to BusRun top channel 7/8" x 2.75" [23x70] Maximum spacing 3'-0" [915]. (Optional, ordered separately)

40133-01 for One Channel Bus

**Mounting Diagram**

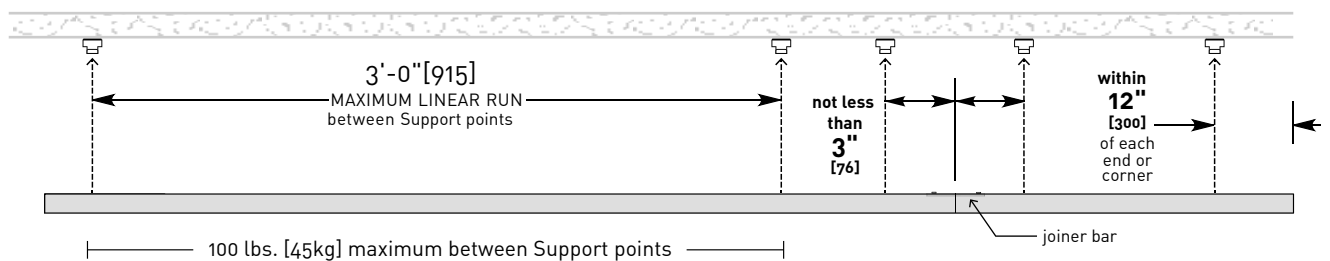

Extrusion Profile: **BUS-08** | Mounting Condition: **Wall (W)**

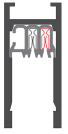

**Feed Options**

**EEF-08W**  
 **EEC-08W (CL)**



End End Feed:  
Whip Style  
1/2" NPSM or 20mm  
end conduit

**Max Load**  
60 amp at 12v, 120v,  
240v, 277v

**TEF-08W**  
 **TEC-08W (CL)**

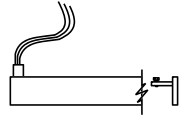

Top End Feed:  
Whip Style  
1/2" NPSM or 20mm  
top conduit

**Max Load**  
60 amp at 12v, 120v,  
240v, 277v

**SEF-08W**  
 **SEC-08W (CL)**

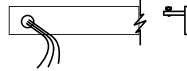

Side End Feed:  
1/2" NPSM or 20mm  
side conduit

**Max Load**  
60 amp at 12v, 120v,  
240v, 277v

**EEB-08W**

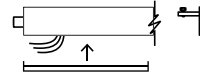

End End Feed:  
Splice Box Style  
1/2" NPSM or 20mm  
end conduit

**Max Load**  
30 amp at 120v, or  
16 amp at 240v

**TEB-08W**

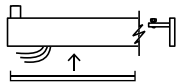

Top End Feed:  
Splice Box Style  
1/2" NPSM or 20mm  
top conduit

**Max Load**  
30 amp at 120v, or  
16 amp at 240v

**TCB-08W**

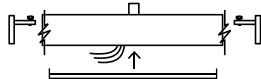

Top Center Feed:  
Splice Box Style  
1/2" NPSM or 20mm  
top conduit

**Max Load**  
30 amp at 120v, or  
16 amp at 240v

**TCF-08W**

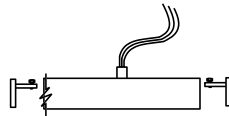

Top Center Feed:  
Whip Style  
1/2" NPSM or 20mm  
top conduit

**Max Load**  
60 amp at 12v, 120v,  
240v, 277v

**Notes:**

1. All Splice Box feeds are 30 amp max load.
2. All feeds are supplied with two end caps.
3. Feeds cannot be modified.
4. Feeds can be made 10" to 120" long.