

MODEL NUMBER: B-B4-AR111-Watt-230-TL-MB/Color	FIXTURE TYPE: N/A	SCALE: NTS	FILE NUMBER: SlotFix.\B-Line-SizeB-TL-230.dwg	DATE: 6/20/07	NO.	REVISIONS DESCRIPTION	BY	DATE
PROJECT NAME:	APPROX. WEIGHT: N/A	DRAWN BY: BJG	CK'D BY: SDP	FIXTURE DESCRIPTION: 4 LAMP RECESSED GIMBAL DOWNLIGHT - TRIMLESS				

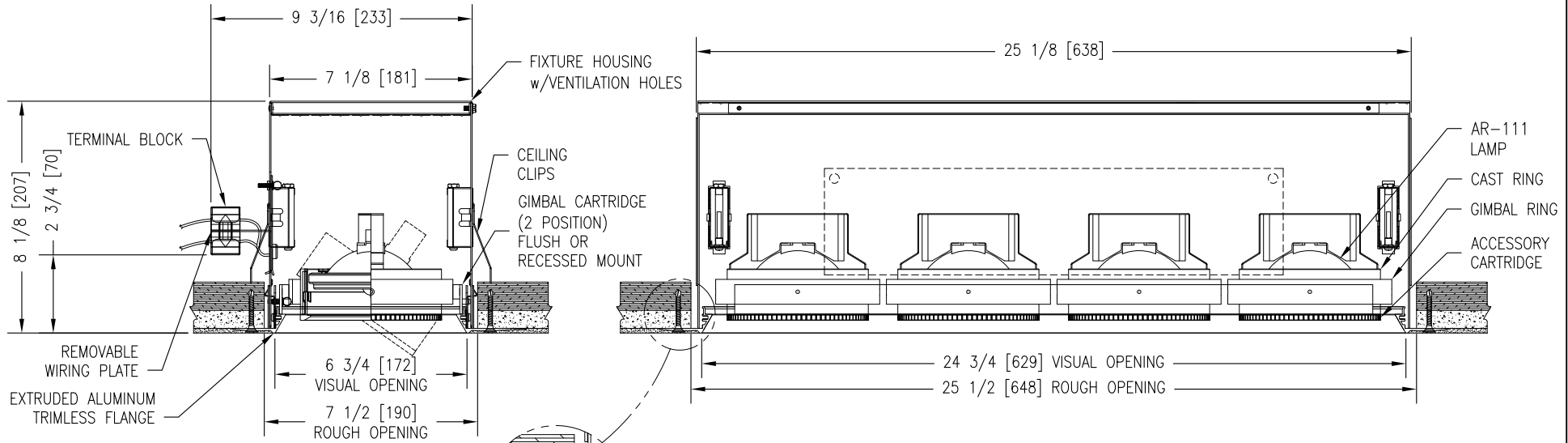

OPTIONAL BUTTERFLY BRACKETS SHIPPED SEPARATELY

MAX TILT OF FIXTURE HEAD:
SHORT AXIS IS 35° FROM VERTICAL
LONG AXIS IS 35° FROM VERTICAL

INSTALLATION NOTE:
WHEN WIRING THIS FIXTURE, ALLOW ENOUGH LENGTH OF FLEXIBLE CONDUIT, SUCH THAT THE WIRING COMPARTMENT CAN BE COMPLETELY REMOVED FOR SERVICING THROUGH THE APERTURE OF THE FIXTURE.

INSTALLATION INFORMATION:
DO NOT INSTALL INSULATION WITHIN 3" (76mm) OF ANY PART OF THIS FIXTURE. DO NOT BLOCK VENT HOLES ON FIXTURE. MAXIMUM AMBIENT TEMPERATURE NOT TO EXCEED 35°C.

DIMMING INFORMATION:
THE MANUFACTURER OF THE ELECTRONIC TRANSFORMERS USED IN OUR INTEGRALLY TRANSFORMED LIGHTING FIXTURES SAYS THAT THE TRANSFORMERS ARE SUITABLE FOR "ALL LEADING AND TRAILING EDGE DIMMER SYSTEMS". WHILE WE STAND BEHIND THIS STATEMENT, WE WILL NOT BE RESPONSIBLE FOR ANY NOISE OR OTHER COMPATIBILITY ISSUES WITH ANY DIMMING OR CONTROL SYSTEM AND STRONGLY RECOMMEND THAT THE UNITS BE TESTED BY THE CUSTOMER TO ENSURE THEIR PERFORMANCE SATISFACTION. LITELAB WILL FURNISH UNITS FOR TEST AT THE CUSTOMER'S REQUEST.

INPUT REQUIREMENTS:
REMOTE POWER SUPPLIES (INCLUDED)
APPROVED LOW VOLTAGE POWER SUPPLY SUITABLE FOR 4 75W AR-111 12 VOLT LAMP

LAMP SPEC: (ORDERED SEPARATELY)
AR-111 75W

ACCESSORIES:
ORDERED SEPARATELY (SIZE S)
FINISHES: (MB/Color)
(HOUSING INTERIOR IS BLACK)
(SPECIFY TRIM-CARTRIDGE ASSEMBLY COLOR)
WHITE (P)
MATTE BLACK (MB)
BEADBLAST (BB)
CUSTOM PAINT (CP)

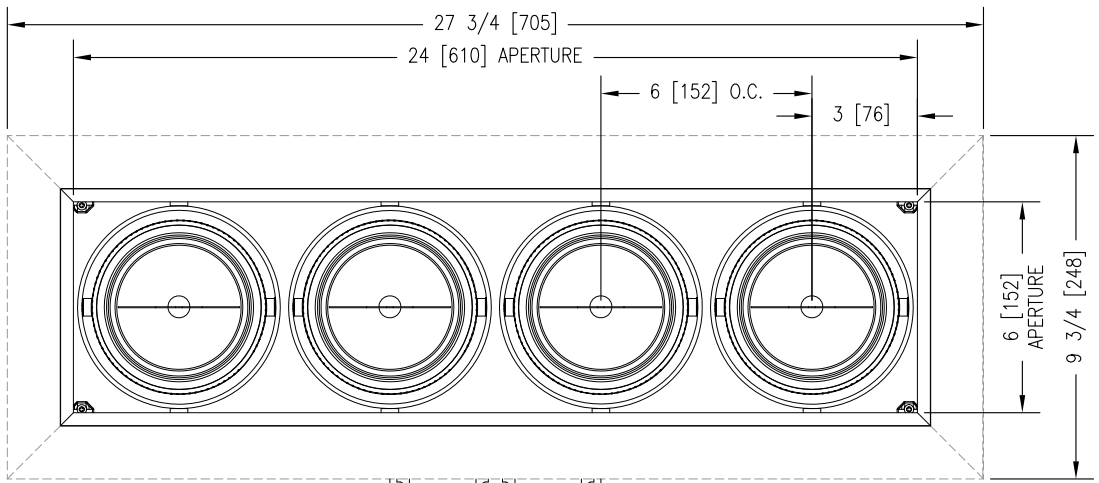

QTY. (4) TERMINAL BLOCK PROVIDED FOR 12V INPUT POWER FROM REMOTE POWER SUPPLY (BY OTHERS)

